

**FINAL REPORT
DIPA BIOTROP 2018**

**STUDY ON ESTABLISHMENT OF
NEW ECOSYSTEM AND ITS RELATION WITH
THEIR FEEDING ECOLOGY: AN ATTEMPT
OF SEA RANCHING FOR *Holothuria atra***

Names of the Researcher

1. Ir. Retno Hartati, MSc.
2. Prof. Dr. Ir. Muhammad Zainuri, DEA.
3. Prof. Dr. Ir. Ambariyanto, MSc.
4. Ir. Widianingsih, MSc.

**MINISTRY OF NATIONAL EDUCATION AND CULTURE
SECRETARIAT GENERAL
SEAMEO SEAMOLEC
SOUTHEAST ASIAN REGIONAL CENTRE FOR TROPICAL BIOLOGY
(SEAMEO BIOTROP)
2018**

1. Research Title : Study on establishment of new ecosystem and its relation with their feeding ecology : An attempt of sea ranching of *Holothuria atra*
2. Research Coordinator
a. Name : Ir. Retno Hartati, MSc.
b. Gender : Female
c. Occupation : Student of Doctorate Program of Marine Science
3. Institution
a. Name of Institution : Faculty of Fisheries and Marine Science
b. Address : Jl. Prof. Soedharto, SH. Kampus Tembalang, Semarang
c. Telephone/Fax. : 0247474698/0247474698
d. Email Address : fpik@undip.ac.id
4. Research Schedule : 9 months
5. Research Budget :

Bogor, 03 December 2018

Endorsed by
Deputy Director for Programm

Research Coordinator

Dr. Jesus C. Fernandez

Ir. Retno Hartati, MSc.
NIP. 196207111987032001

Approved by
Director of SEAMEO BIOTROP

Dr. Irdika Mansur, M.For.Sc.
NIP 19660523 199002 1 001

Cover	
Approval Sheet	ii
List of Table	v
List of Figure	vi
Abstract	viii
1. Introduction	1
1.1. Background	1
1.2. Objectives	1
1.3. Expected Output	3
2. Benefit and Importance of Research	3
3. Metodology	7
4. Result and Discussions	10
5. Conclusions	29
6. References	29
7. Appendices	36

List of Table

Tabel 1.	Expected Outputs and Outcomes of Research activity of 2018-2019	3
Table 2.	Some of sea cucumber sea ranching worldwide.	4
Table 3	Number of individuals resulted from fission on sea cucumbers which are kept with different stocking and stocking times (Stocking density 30, 20, 10 individuals / cages; A = stocking at month 0 from the start of installation of bottom cages, B = month 1 after cages is installed, and C = month 2 after cages installed)	14

List of Figure

Figure 1	Fishbone diagram Roadmap of Sea cucumber Research done by Hartati et al	3
Figure 2	The research location of Teluk Awur Jepara	7
Figure 3	Bottom cage design for <i>H. atra</i> rearing	7
Figure 4	Position of bottom cages in Teluk Awur waters of Jepara	7
Figure 5	Weighing and measuring the sea cucumber of <i>Holothuria atra</i> .	8
Figure 6	Position of baottom cage for <i>H. atra</i> rearing in Awur Waters, Jepara.	10
Figure 7	Average weight of sea cucumber <i>Holothuria atra</i> reared at different stocking times and densities (A = stocking at month 0 from the start of installation of bottom cages, B = month 1 after cages is installed, and C = month 2 after cages installed)	11
Figure 8	Growth of weight of sea cucumber <i>Holothuria atra</i> reared at different stocking times and densities in the end of experiments (A = stocking at month 0 from the start of installation of bottom cages, B = month 1 after cages is installed, and C = month 2 after cages installed)	12
Figure 9	Survival rate of sea cucumber <i>Holothuria atra</i> reared at different stocking times and densities (A = stocking at month 0 from the start of installation of bottom cages, B = month 1 after cages is installed, and C = month 2 after cages installed)	13
Figure 10	Survival rate of sea cucumber <i>Holothuria atra</i> reared at different stocking times and densities in the end of experiments (A = stocking at month 0 from the start of installation of bottom cages, B = month 1 after cages is installed, and C = month 2 after cages installed)	14
Figure 11	Sea cucumbers that are undergoing fission (A), have just undergone fission and the wound of the cleavage has been closed (B) and the newly regenerated (C) (→ arrow mark k is position of fission / fission plane and regeneration)	15
Figure 12	Sea cucumbers that experience fission and have regenerated (→ Arrow mark is the position of mission / plane plane and the part of the body that is degenerated)	15
Figure 13	Average phosphate levels (PO ₄ -P) (A) and nitrate (NO ₃ -N) (B) (mg / gr) in cage sediments of <i>H. atra</i> reared at different densities	16
Figure 14	Average phosphate levels (PO ₄ -P) (A) and nitrate (NO ₃ -N) (B) (mg / gr) in cage water of <i>H. atra</i> reared at different densities	17
Figure 15	Concentration of chlorophyll-a, chlorophyll-b, and	18

chlorophyll-c, in sediments of sea cucumber *H. atra* cages which are reared at different densities

Figure 16	Concentration of total chloropigment, phaeophytin and carotene in sediments of sea cucumber <i>H. atra</i> cages which are reared at different densities.	19
Figure 17	Percentage of gravel, coarse sand, fine sand and silt (%) in cage sediments where sea cucumbers are reared with different stocking densities.	20
Figure 18	Average Temperature ($^{\circ}$ C) of sea water in <i>H. atra</i> rearing cage with different stocking density	21
Figure 19	Average salinity ($^{\circ}$ oo) of sea water in <i>H. atra</i> rearing cage with different stocking density	21
Figure 20	Average pH of sea water in <i>H. atra</i> rearing cage with different stocking density	21
Figure 21	Average dissolved oxygen of sea water in <i>H. atra</i> rearing cage with different stocking density	22

Abstract

One group of marine invertebrates that are mostly captured is sea cucumbers. Strong market demand and uncontrolled exploitation and / or inadequate fisheries management have caused many stocks of sea cucumbers in more capture conditions. One suggested effort to overcome this problem is sea ranching. But there are no publications about sea ranching sea cucumbers in Indonesia. Sea ranching for *Holothuria atra* is investigated because this sea cucumber can be a source of protein for human food, bioactive molecules for marine pharmaceuticals and cosmetics, ecologically very important role for bioturbation and remineralization sediments. This study aims to determine the biological, physical, chemical characteristics and formation of the sea ranching *H. atra* habitat, its growth and survival rate and determine the best stocking density for sea ranching sea cucumber *H. atra*.

H. atra is taken from Panjang Jepara Island waters and reared in the bottom cages in Teluk Awur waters, Jepara with a density of 30, 20, 10 individuals per cages measuring of 2 x 2 x 1.8 meter³ with different the stocking time i.e. stocked when the cage weres installed, the second and third month after the cages were installed. Sediment and marine characteristics of sea cucumber habitat in cages were measured during the study.

The results showed that growth determined based on weight gain of sea cucumber *H. atra* at the end of the study were fluctuated, where a low stocking density gave higher weight gain than a high stocking density. The highest weight gain was obtained in the density of 10 individuals / cages in the second stocking. The lowest weight gain on the stoking density of 30 individuals / cages at the first stocking. The highest survival rate of *H. atra* at the end of the study was reared in 30 indiv./ cages stocking densities, which was 93% in the 3rd stocking, which means that sea cucumbers were only reared for 3 months. The highest mortality occurred at a density of 20 indiv. / cages so that the survival rate is low (45%) in the 1st stocked, or in the 5th month of rearing. Fission that occurs affects *H. atra* growth and survival rate. Among the water quality parameters, the concentration of chlorophyll a, b, c, phaephytin and carotene fluctuate according to the time of sea cucumber rearing caused by feeding and bioturbation by sea cucumbers.

Keywords: stocking density, time of stocking, chlorophyll, fission. sediment

1. Introduction

1.1. Background/Rationale

In the recent decades, invertebrate fisheries have expanded in catch and value worldwide (Anderson et al., 2011). One increasingly harvested marine invertebrates group is sea cucumbers. In Indonesia, sea cucumber is called Teripang, trepang, Timun Laut or gamat (Hartati et al., 2015). Strong market demand and uncontrolled exploitation and/or inadequate fisheries management have led to many sea cucumber stocks becoming heavily overfished (Conand, 2004). One effort suggested to overcome this problem is sea ranching.

Sea ranching is essentially a 'put and take' activity, where cultured or wild juveniles are released into an area of natural habitat and harvested when they reach a commercially optimal size (Bell et al., 2008a;b). There are some advantage of sea ranching i.e. inputs are nominally lower, as the processes between release and harvest are largely left to nature and the level of care that can be offered to sea cucumber throughout the growth process is reduced, yet still able to produce marketable size of sea cucumber. However, no published work is available on sea ranching of sea cucumber in Indonesia. Therefore, with the special objectives to avoid overexploitation of natural populations, it is needed a research on sea ranching of sea cucumber. This research will also be able to provide knowledge for a better understanding and application in marine conservation, population genetics and connectivity patterns

A recent trend by fishers in Indonesia is to grow-out wild sea cucumbers in sea pens, this provides a way to restore the damaged fisheries without having to formalise no-take zones or establish fishing rights for sea cucumbers. In the case of sandfish, Bell et al. (2008) said that this simple way would involve just one additional activity by fishers: rearing sea cucumbers harvested from the wild in sea pens until marketable size. Some of the key researchable knowledge gaps in restocking of tropical sea cucumbers derived from Purcell et al (2012) which will be conducted in this research are optimal habitats for release into sea pens or for sea ranching, suitable stocking densities in the sea as a function of habitat features, effects of behavioural conditioning and acclimation on post-release survival of juveniles and strategies for improving governance and communication as establishment sea cucumber restocking.

As it has been gathered by Purcell *et al.*, (2012), the recent published data and unpublished data from mariculture programmes on sea cucumber in the Indo-Pacific that provide hatchery production, use of juveniles (for experimental, sea or pond farming, sea ranching, and stock enhancement), and proponents information, none was came from Indonesia. This might due to lack of international publication on sea cucumber

research in Indonesia. More over, in the side of conservation area, no published work is available on sea ranching of sea cucumber in Indonesia. With the declining natural stock of sea cucumber (Hartati et al, 2015), it is urgent to conduct works on sea cucumber sea ranching for continuation production and conservation.

Here we proposed sea ranching for *Holothuria atra* because they provide Protein sources for human food, bioactive molecules for marine pharmaceutical, ecologically important for their sedimen bioturbation and remineralization and also they have reproduction specific. i.e. asexual reproduction through natural fission.

The result of the research will be published in international journal (Journal of BIOTROPIKA and Biodiversity). In the end of year 2, the result of the research not only will be written in international journal (Journal of BIOTROPIKA and Biodiversity) but also as simple applicable technology (Teknologi Tepat Guna) manual which could be applied to coastal community to enhance sea cucumber production and conservation.

1.2.Objectives

The longterm objectives of the reasearch is to better understanding of sea cucumber sea ranching and its application for marine biodiversity conservation.

Special Objectives of the research are

- 1) To determine best stocking density for sea cucumber ranching
- 2) To measure the biological, physical, chemical characteristic of the habitat of ranching *H. atra*
- 3) To understand the process of habitat establishment in the habitat of sea raching for *H. atra*
- 4) To understand acclimation process in a new habitat of post-release of *H. atra*
- 5) To measure the performance (growth and survival rate) of *H. atra* in new habitat of sea ranching

1.3.Expected Output

The expected output and outcome as indicator performance of the project is presented in Table 1.

Tabel 1. Expected Outputs and Outcomes of Research activity of 2018-2019

Year	Activity	Output	Outcome indicator
1. 2018	Experiment of different stocking density and stocking time of wild juveniles sea cucumber in bottom cages	Performance of sea cucumber stocked with different stocking density and stocking time has been determined Paper presented in National/international seminar 1 article submitted to Journal BIOTROPIKA with tentative title : The effect of stocking density and stocking time on performance of <i>H. atra</i> during rearing in bottom cages.	1 draft article has been submitted international journal 1 article published in Proceeding of International seminar

2. Benefit and Importance of Research

This proposed research is on the track of previous research done by Hartati *et al* (2000-2002; 2003-2005; 2007-2009; 2009-2012; 20105-2016) as explained in Figure below.

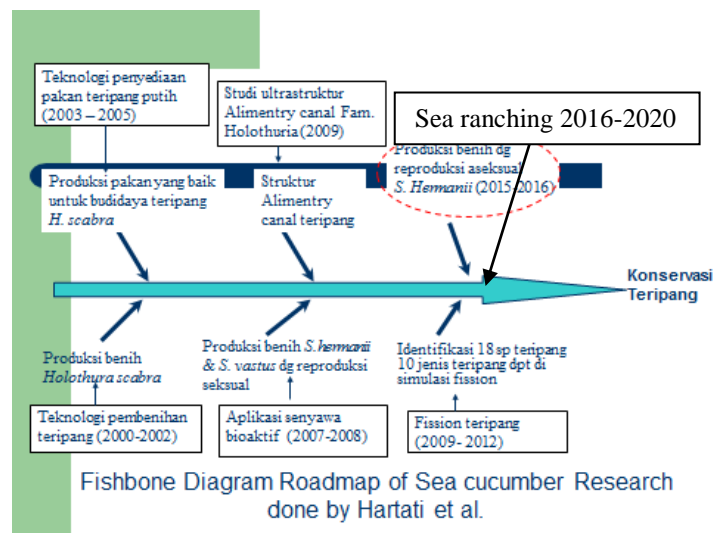

Figure 1. Fishbone diagram Roadmap of Sea cucumber Research done by Hartati et al.

It is very limited data on sea cucumber ranching in Indonesia. Restocking program for 4 species of sea cucumber in Karimunjawa Island (BTN Karimunjawa 2009) but there were no monitoring n evaluation program so there were no information on the result. Other works was sea ranching of 150 indiv. *H. scabra* in Buleleng Waters, Bali (1 March 2018) do by Marine Science Dept-Univ. Ganesha, BBRBL, Gondol, KKP, NGO) but it is limited as seremonial release of animals and no other information yet.

During 2016-2017 Hartati et al. did research on determining the location for sea ranching. Habitat characteristic of two selected locations for sea cucumber ranching purposes : compare and contrast of 2 purpose habitat (Teluk Awur and Bandengan waters of Jepara

area) has been published (Hartati et al., 2017a) and the abundance of prospective natural food for sea cucumber *Holothuria atra* at Karimunjawa Island waters, Jepara, Indonesia (Hartati et al., 2017b).

There were also limited data on sea ranching program worldwide. Some of data mentioned in Table 2.

Table 2. Some of sea cucumber sea ranching worldwide.

Country	Species cultured	Annual production of 1 g juveniles	Use of juveniles	Proponents	Start year to end year
Australia (Northern Territory)	<i>Holothuria scabra</i>	62,000+	Sea ranching; pond farming	Tasmanian Seafoods Pty. Ltd.	2004–ongoing
Australia (Queensland)	<i>H. scabra</i>	500,000	Sea ranching	Bluefin Seafoods	2003–2009
Australia (Queensland)	<i>H. lessoni</i>	330,000	Sea ranching	Bluefin Seafoods	2004–2009
Australia (Queensland)	<i>H. scabra</i>	1000	Experimental	QLD DPI&F	2004–2007
Canada	<i>Parastichopus californicus</i>	n/a	Pond farming	Sustainable Ecological Aquaculture (SEA)	2009–ongoing
China	<i>Apostichopus japonicus</i>	> 6 billion	Sea ranching; pond farming	Government and private hatcheries	1990–ongoing
Ecuador	<i>Isoctichopus fuscus</i>	n/a	Experimental	n/a	2002–2008
Fiji	<i>H. scabra</i>	500	Experimental	Hunter Pearls, Fiji MAFF	2008–2010
FSM (Pohnpei)	<i>H. scabra</i>	10,000	Experimental	College of Micronesia, Land Grant Program	2009–ongoing
FSM (Yap)	<i>Actinopyga</i> sp.	n/a	Stock enhancement	n/a	2007
India (Tuticcom)	<i>H. scabra</i>	3000	Experimental	Central Marine Fisheries Research Institute	1988–2006
India (Tuticcom)	<i>H. spinifera</i>	na	Experimental	Central Marine Fisheries Research Institute	2001–2006
Iran (Bandar-e Lengeh)	<i>H. scabra</i>	na	Experimental	Persian Gulf Molluscs Research Station	2011
Japan	<i>A. japonicus</i>	> 3 million	Stock enhancement	n/a	1977–ongoing
Kiribati	<i>H. fuscoglypha</i>	500–8000	Stock enhancement	Kiribati Ministry of Fisheries	1997–2009
Madagascar	<i>H. scabra</i>	200,000	Sea farming (pens)	Blue Ventures, TMD, MH,SA	2007–ongoing
Maldives	<i>H. scabra</i>	5 million	Sea ranching	Masmeeru Pty Ltd	1997–ongoing
Mexico	<i>I. fuscus</i>	300,000	Pond farming	Acuacultura Dos Mil	2008–ongoing
New Caledonia	<i>H. scabra</i>	18,000	Experimental	WorldFish Center	2000–2006
New Caledonia	<i>H. scabra</i>	450,000+	Sea ranching; pond farming	Société d'élevage aquacole de la Ouenghi	2011–ongoing
New Zealand	<i>Australostichopus mollis</i>	n/a	Experimental	National Institute of Water and Atmosphere	2007–ongoing
Palau	<i>Actinopyga mauritiana</i>	500,000	Stock enhancement	Government hatchery, Korean technicians	2009–2011
Palau	<i>Actinopyga miliaris</i>	50,000	Stock enhancement	Government hatchery, Korean technicians	2009–2011
Philippines (Bolinao)	<i>H. scabra</i>	32,000	Sea ranching	University of the Philippines MSI	2001–ongoing
Philippines (Mindanao)	<i>H. scabra</i>	15,000	Sea ranching; pond farming	University of the Philippines, DOST, PCARMD	2009–ongoing
Philippines (Bolinao)	<i>Stichopus horrens</i>	500	Experimental	University of the Philippines MSI	2009–ongoing
Philippines (Dagupan)	<i>H. scabra</i>	20,000	Experimental	NFTDC-NFRDI	2009–2011
Philippines (Iloilo)	<i>H. scabra</i>	11,000	Experimental	SEAFDEC	2010–ongoing
Saudi Arabia	<i>H. scabra</i>	n/a	Sea ranching	National Prawn Company	n/a
Solomon Islands	<i>H. scabra</i>	n/a	Experimental	WorldFish Center	1996–2000
USA (Alaska)	<i>P. californicus</i>	n/a	Experimental	Alutiiq Pride Shellfish Hatchery	2010–ongoing
Vietnam	<i>H. scabra</i>	200,000+	Pond farming	RIA3	2001–ongoing

Teripang, Timun Laut or Sea cucumbers are elongated tubular or flattened soft-bodied marine benthic invertebrates, typically with leathery skin, ranging in length from a few millimetres to a metre (Hartati et al., 2015) belong to belonging to the class Holothuroidea under the phylum Echinodermata, it is usually occur in the shallow benthic areas and deep seas. The major product in the sea cucumber is the boiled and dried body-wall, familiarly known as teripang/trepang, ‘bêche-de-mer’ or ‘gamat’, for which there is an increasing demand for food delicacy and folk medicine in the communities of Asia and Middle East (Tian et al., 2005).

The total global catch of sea cucumbers is in the order of 100,000 tonnes of live animals annually (Purcell et al., 2010, 2012b). More than 66 species are now harvested around the world and exported to Asian markets (Choo, 2008; Conand, 2008; Kinch et al., 2008; Purcell et al., 2010; 2012a,b,c). In Indonesia, there have been more than 23 species come into market (Pradina et al., 2012), such as teripang putih or teripang pasir

(*Holothuria scabra*), teripang hitam (*H. edulis*), teripang getah or teripang keling (*H. vagabunda*), teripang merah (*H. vatiensis*), teripang coklat (*H. marmorata*) and teripang hitam (*H. Atra*). The area where sea cucumber exploited are Central Java, East Java, Bali, Nusa Tenggara Barat, Nusa Tenggara Timur, Iran, Sulawesi Tenggara, Sulawesi Selatan, West coast of Sumatera, Sumatera Utara dan Aceh (Wiadnyana *et al.*, 2009).

As overfishing continues to diminish stocks of high-value sea cucumbers in the tropics such as in Indonesia (Anderson *et al.*, 2010; Domínguez-Godino *et al.*, 2015) and places more species in danger of extinction (Polidoro *et al.*, 2011), it may need to close fishing of wild stocks. Sea ranching then faces a challenge of proving that harvests are from cultured animals or risk opening opportunities for black marketing of protected wild individuals and undermining conservation efforts (Eriksson *et al.*, 2012).

Small-scale fisheries for sea cucumbers have provided livelihoods for coastal communities in Indonesia for centuries (Pradina *et al.*, 2012). However, increasing coastal populations, limited opportunities to earn income, and access to more effective fishing equipment have combined with three features of the biology of tropical sea cucumbers and the market place to cause chronic overfishing of these valuable resources. These three features are the ease with which sedentary sea cucumbers can be caught from shallow coastal waters (Lincoln-Smith *et al.*, 2006), low and sporadic rates of recruitment (Uthicke, 2004; Uthicke, *et al.*, 2004; and intense demand for teripang or trepang or be[^]che-de-mer (boiled and dried sea cucumbers) from exportee country such as China (Lovatelli *et al.*, 2004). In Indonesia, the sign of depleted sea cucumber stock showed by decreased production, reduced size of individual catch, farther and deeper fishing area, and more new species introduced in the market (Hartati *et al.*, 2009a,b; Pradina *et al.*, 2012).

Sea ranching is essentially a ‘put and take’ activity, where cultured or wild juveniles are released into an area of natural habitat and harvested when they reach a commercially optimal size (Bartney, 2007; Bell *et al.*, 2008a;b). Compared with intended sea cucumber culture, some advantage of sea ranching i.e. inputs are nominally lower, as the processes between release and harvest are largely left to nature and the level of care that can be offered to sea cucumber throughout the growth process is reduced, yet still able to produce marketable size of sea cucumber.

Expanding current fishing practices into ‘capture and culture’ operations (concept of sea ranching) promises to create multiple, protected spawning aggregations to supply the recruits needed to replenish local fisheries. There are at least four advantages to

this proposed way of restoring fisheries for sea cucumber. First, it does not require fishing patterns to be changed in open access fisheries, where sea cucumber of any size are often collected. Second, it provides incentives for fishers because they own the sea cucumber once they are placed in their sea pens. Third, it enables fishers to add great value to their catch because they can grow sea cucumber, at no or little cost for feed, to sizes where they obtain a premium price. Fourth, it changes the effects of the current harvesting regimes from damaging to improving the potential for replenishment by overcoming depensatory ('Allee') effects. (Bell et al., 2008).

Grow-out in sea pens or in open sea-ranching scenarios Purcell et al (2012) will need to contend with risks of environmental perturbations, predation, poaching and social conflicts. Sociological issues, such as governance, consultation and poaching, are significant and must be tackled at the outset. The sea ranching is also aimed to improving survival of juveniles released in the wild, reduced predation through predator removal, customised release habitats and increased size at release. Monitoring and evaluation by improved tagging (Bartley, 2007) is to carry out to gauge the success of sea ranching.

3. Methodology

3.1. Research Component

The research material are Teripang hitam (Black Sea cucumber, *Holothuria atra*) taken from Panjang Island Waters, Jepara, size of 100-150 grams as been used by Hartati, *et al.*, (2005); Xie, *et al.*, (2013) dan Zonghe *et al.*, (2014). The research will be located in Teluk Awur waters, Jepara (Figure 2).

3.2. Research Location

The site survey was conducted on April 3, 2018 in the waters adjacent to (MeCok mangrove vegetation). It has been found a suitable location for cages of *Holothuria atra*, which is with a muddy sand substrate, there are seagrasses and seaweed. The coordinates of the position of the cage to be built are 06° 37 '43.8 "S and 110° 38' 31.7" E. (Figure 2). Next is the preparation / procurement of equipment.

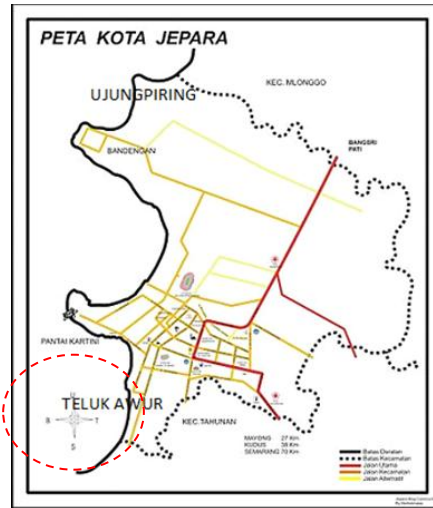

Figure 2. The research location of Teluk Awur Jepara

3.3. Making and installing bottom cage

The making and installation of bottom cage have been carried out on April 5th-15th 2018 at selected location. Nine (9) cages have been made with the size of 2x2x1.5 meters made of wood and bamboo frames and waring nets followed Hartati et al., (2009) designs (Figure 3). The base of the cage is placed on the bottom / sediment / substrate of the sea (Figure 4). The location of the cage is in the area with seagrass bed.

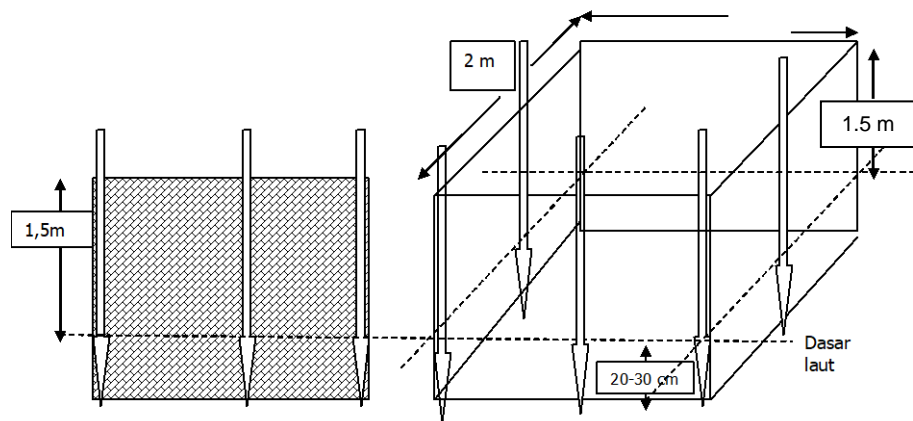

Figure 3. Bottom cage design for *H. atra* rearing

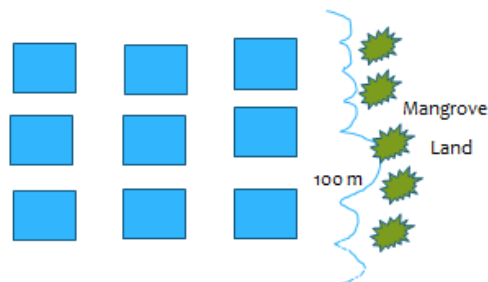

Figure 4. Position of bottom cages in Teluk Awur waters of Jepara.

3.4. Sampling of sea cucumbers in Panjang islands of Jepara and and stocking into cages

The sea cucumber sample that will be tested is taken from the waters of P. Panjang on May 15-16 2018, and takes it to the waters of Teluk Awur. 180 individual test sea cucumbers have been taken from Pulau Panjang waters. and stocked in bottom cages with densities of 10, 20 and 30 individuals / karamba, respectively. Before being stocked, the test sea cucumber is weighed and measured in length



Figure 5. Weighing and measuring the sea cucumber of *Holothuria atra*.

The performance of sea cucumber stocked will be determined by their survival rate and growth. The stocking density is assumed affect the behaviour performance due to competition of area and feeding. The samples of bottom sediment and water will taken monthly for biological, physical and chemical parameter. Biological parameter measured will be sea grass, sea weed, phytoplankton, zooplankton, epiphytes, benthic organism. Physical parameter measured will be temperature, salinity, current, organic matter, grain size, light penetration/turbidity. Chemical parameter measured will be DO, pH, NH₃-N, NO₃-N, NO₂-N, PO₄-P, Chlorophyll-a and phaeophytin. The sea cucumber will be measured their length and weight to determine their growth

3.6. Data analyses

The growth rate (Weight gain) were calculated as follows :

$$\text{Weight Gain} = W_2 - W_1$$

Noted : W_1 = Weight of sea cucumber at Tn-1 (gram)

W2 = Weight of sea cucumber at Tn (gram)

Survival rate will be calculated as follows.

$$SR (\%) = (N_t / N_0) \times 100 \%$$

Noted : N_t = Number sea cucumber alive at Tn

N₀ = Number sea cucumber stocked at T₀

Chemical, physical, biological characteristic will be analysed to support growth data.

4. Results and Discussion

4.1. Preparation

Preparations that have been made include the signing of the Work Agreement (SPK) which was carried out on March 20, 2018 by Signing a Work Agreement (SPK) for 2018 Biotrop DIPA Contract. Work Contract (SPK) Number: 055.11 / PSRP / SC / SPK -PNLT / III / 2018 March 20th, 2018. As Party I is the PPK Seameo Seamolec Working Unit Seameo Biotrop Work Unit Ministry of Education and Culture Secretary General, Mr. Bambang Sulistio, S.Si. (NIP 197606242009101001) with Party II is the Research Center for Regional Study of Tropical Biology (Seameo Biotrop), namely Ir. Retno Hartati, MSc . (NIP. 196207111987032001).

Research coordination and planning meetings were held on March 28th, 2018 with the aim of coordinating research preparation. At this meeting the Team looked back at the research framework and planned research preparation. Surveys and other preparations, especially the making and installation of bottom cages are well planned. Likewise, the process of collecting sea cucumbers from Pulau Panjang waters. Boat rentals and field support personnel were prepared so that the research went well.

4.2. Result of the Research

4.2.1. Research location of the Teluk Awur waters of Jepara.

The research site is located in Teluk Awur waters, Jepara with geographical position of 06 ° 37.437'S, 110 ° 38.317'E. These waters are selected based on the results of previous studies (Hartati et al., 2017). The beach with a gentle slope with rubble near the mainland which is vegetated with quite dense mangrove (Figure 6). But on a 100-meter from the shore the substrate is sandy sediment with a mixture of mud. There is a small stream goes into these waters. Bottom cages were located about 150 meters from the beach.

The bottom cages were made of waring nets with a bamboo frame measuring 2 x 2 meters with a height of 1.5 meters which is installed in waters with a depth of 1.2-1.8 meters.



Figure 6. Position of baottom cage for *H. atra* rearing in Teluk Awur Waters, Jepara.

4.2.2. Measurement of sea cucumber weight

During the rearing of sea cucumbers *H. atra* their weight measurement were done the beginning of the study, every month until the study is completed. The increase in weight of sea cucumbers seems to be influenced by the time of stocking and stocking density. Stocking on the second month after the bottom cage is installed seems to be better than the other time of stocking. Likewise a high stocking density affects the weight of the reared sea cucumber. The graph of the average weight of sea cucumber *H. atra* each month is shown in Figure 7.

Growth calculated based on weight gain of sea cucumber *H. atra* at the end of the study fluctuated, where low stocking density gave greater weight gain than high stocking densities. The highest increase was obtained in the density of 10 individuals / cages in the second stocking. The lowest weight gain in the stocking of 30 individuals / cages at the first stocking (Figure 8)

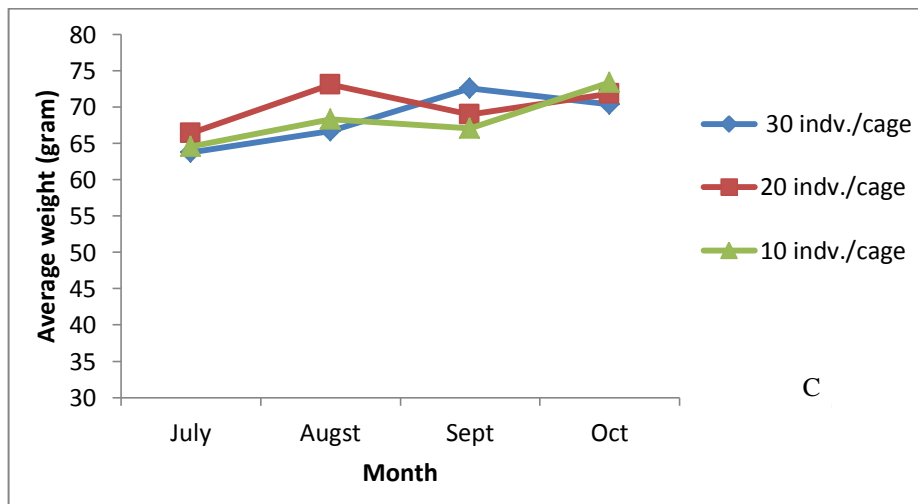
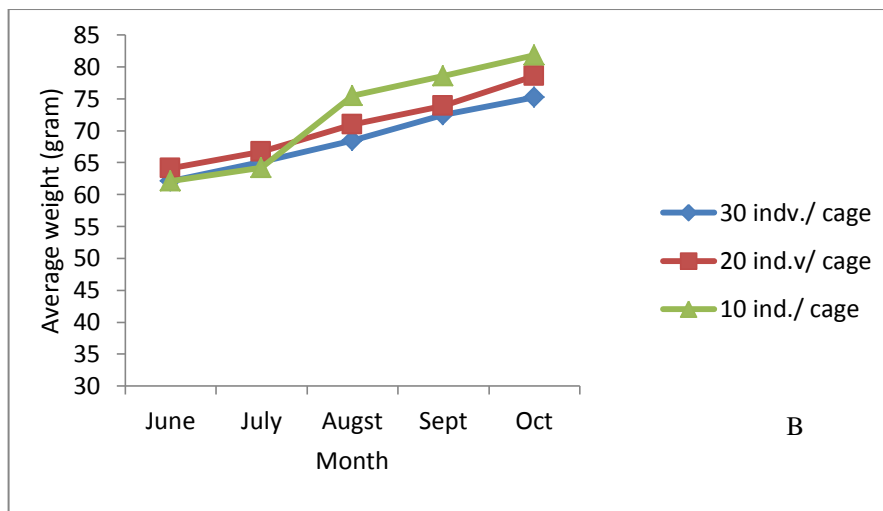
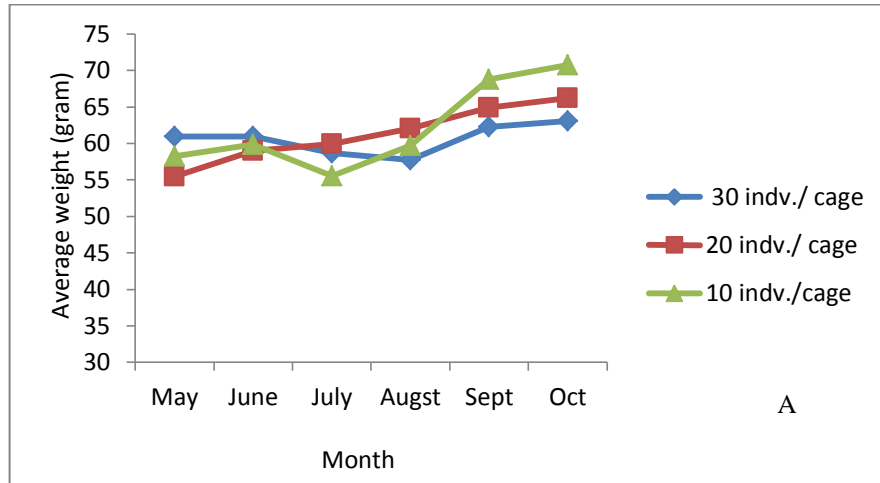

Figure 7. Average weight of sea cucumber *Holothuria atra* reared at different stocking times and densities (A = stocking at month 0 from the start of installation of bottom cages, B = month 1 after cages is installed, and C = month 2 after cages installed)

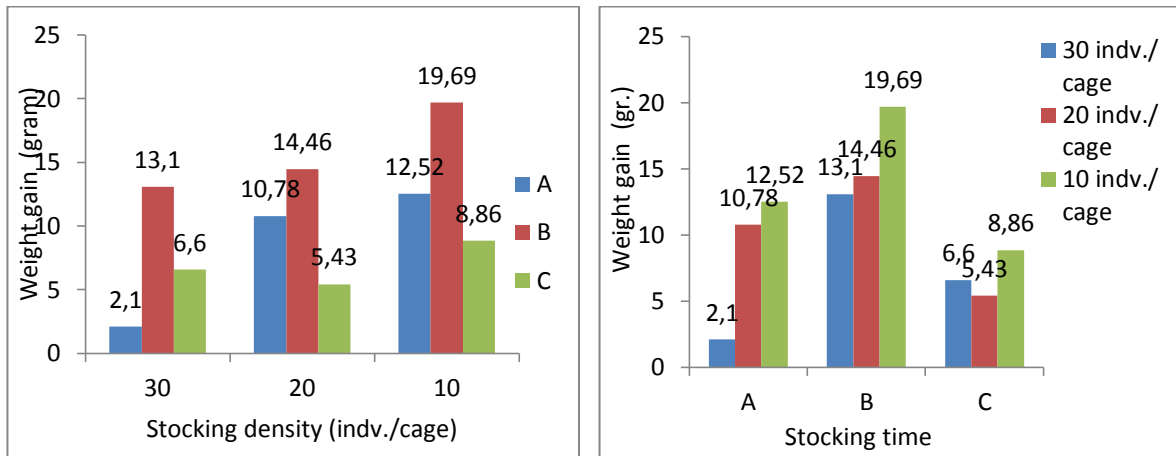

Figure 8. Growth of weight of sea cucumber *Holothuria atra* reared at different stocking times and densities in the end of experiments (A = stocking at month 0 from the start of installation of bottom cages, B = month 1 after cages is installed, and C = month 2 after cages installed)

4.2.3. Survival rate of sea cucumber *H. atra*

The number of sea cucumber *H. atra* that lives at the end of the study is different based on the stocking density. Fluctuations in the number of sea cucumbers occurred, which when calculated based on the survival rate became uncommon because they exceeded 100% (occurring in 10 individual / cage stocking densities, 3rd stocking in September). This occurs because of the phenomenon of fission (asexual reproduction) in sea cucumbers which are reared in cages. The survival of sea cucumbers which are stocked on dense stockings and different stocking times during maintenance is shown in Figure 9.

The highest survival rate of *H. atra* at the end of the study occurred in 30 indiv./cage stocking densities, which was 93% in the 3rd stocking, which means that sea cucumbers were maintained for 3 months. The highest mortality occurred at a density of 20 indiv./cage so that the survival rate is low (45%) in the 1st stocked, or in the 5th month of rearing. The survival rate results are presented in Figure 10.

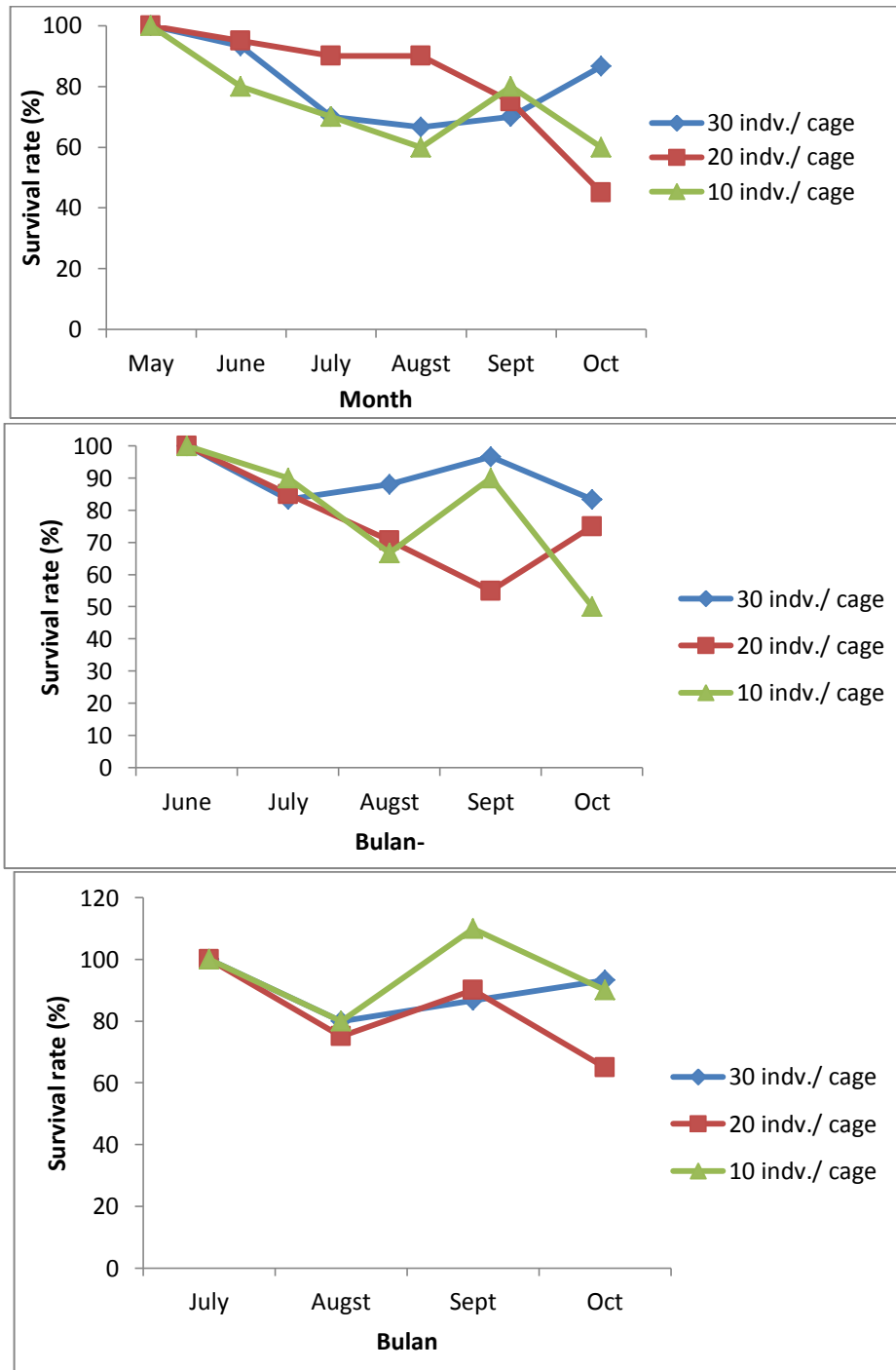

Figure 9. Survival rate of sea cucumber *Holothuria atra* reared at different stocking times and densities (A = stocking at month 0 from the start of installation of bottom cages, B = month 1 after cages is installed, and C = month 2 after cages installed)

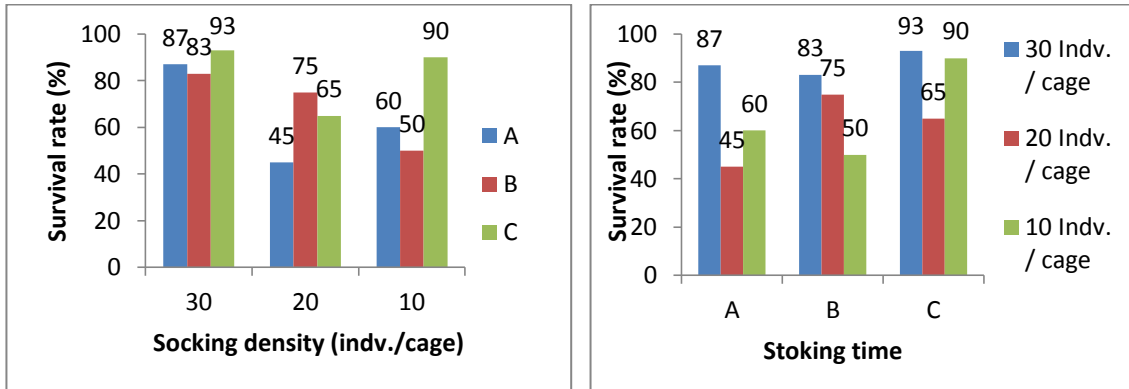

Figure 10. Survival rate of sea cucumber *Holothuria atra* reared at different stocking times and densities in the end of experiments (A = stocking at month 0 from the start of installation of bottom cages, B = month 1 after cages is installed, and C = month 2 after cages installed)

4.2.4. Fission in sea cucumbers reared in the cages

During reared in the cage with different stocking density and stocking time, the sea cucumbers dis asexual reproduction or fission (Table 3). Most of these phenomena were not directly observed, but individual results of fission can be distinguished from normal individuals (Figures 11 and 12).

Table 3. Number of individuals resulted from fission on sea cucumbers which are kept with different stocking and stocking times (Stocking density 30, 20, 10 individuals / cages; A = stocking at month 0 from the start of installation of bottom cages, B = month 1 after cages is installed, and C = month 2 after cages installed)

Month-	A			B			C		
	30	20	10	30	20	10	30	20	10
0	0	0	0	0	0	0	0	0	0
1	0	5	0	1	0	0	3	5	0
2	0	0	0	1	0	1	3	3	4
3	1	0	0	4	4	7	2	2	1
4	5	4	2	2	5	0	-	-	-
5	2	1	0	-	-	-	-	-	-
Total	8	11	2	8	9	8	8	10	5

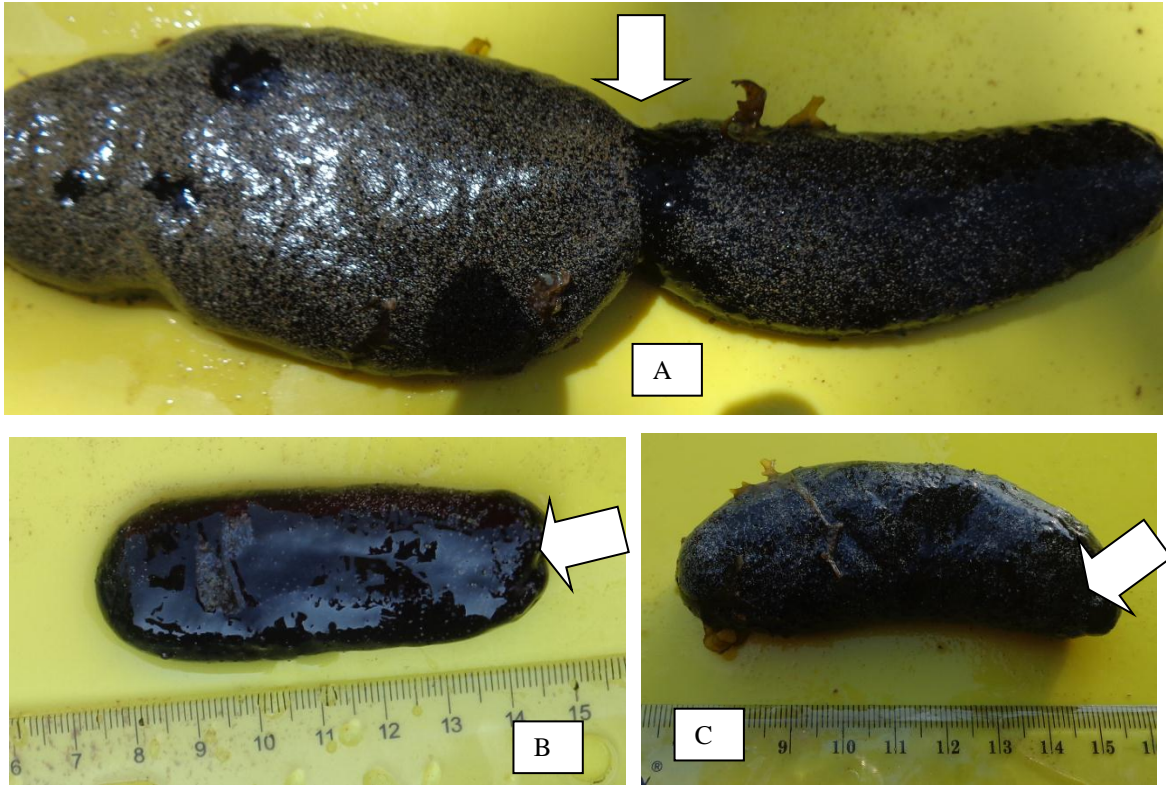

Figure 11. Sea cucumbers that are undergoing fission (A), have just undergone fission and the wound of the cleavage has been closed (B) and the newly regenerated (C) (→ arrow mark k is position of fission / fission plane and regeneration)



Figure 12. Sea cucumbers that experience fission and have regenerated (→ Arrow mark is the position of mission / plane plane and the part of the body that is degenerated)

4.2.5. Water Quality Parameters

Seawater and sediment samples were taken from *H. atra* rearing cage with different stocking densities and times were analyzed for nitrate (NO₃-N) and phosphat (PO₄-P) levels and the results are presented in Figures 13 and 14.

In general, phosphate levels (PO₄-P) in sediments increase with the time of rearing of sea cucumbers and their levels are higher in sediments in cages than in controls where there are no sea cucumbers. Nitrate (NO₃-N) levels decreased with the time of sea cucumber rearing, the highest at 30 indiv. / cage. The cage sediment nitrate level with 10 indiv stocking densities. / cage is almost the same as the control.

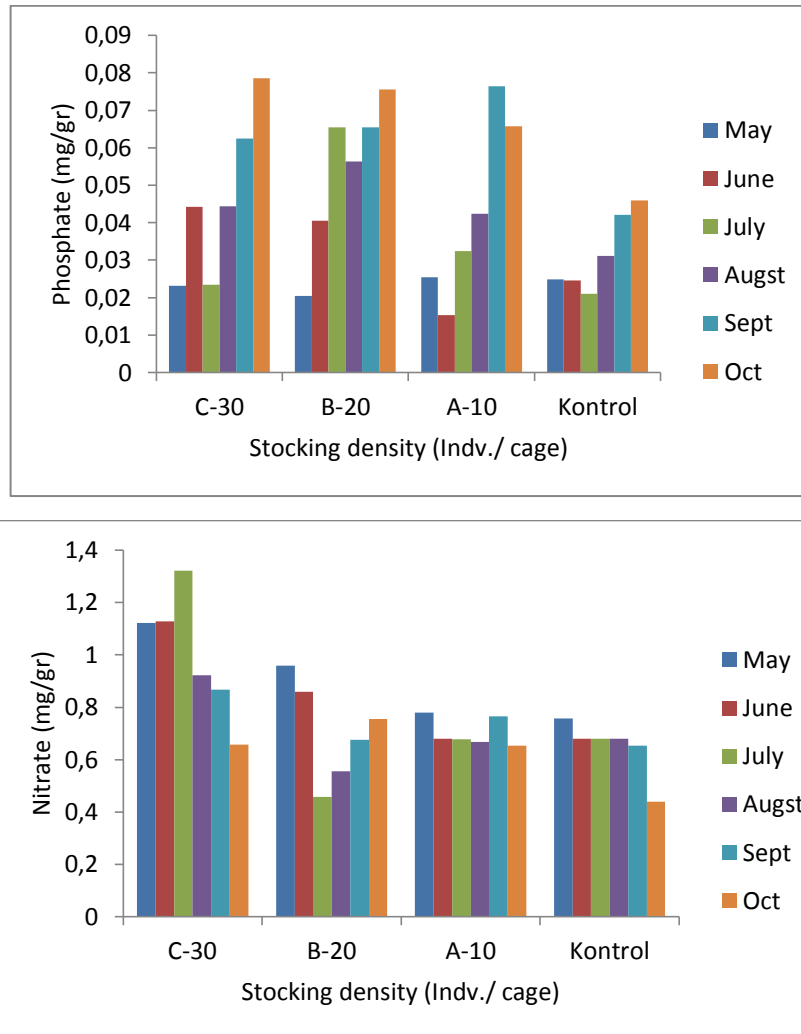

Figure 13. Average phosphate levels (PO₄-P) (A) and nitrate (NO₃-N) (B) (mg / gr) in cage sediments of *H. atra* reared at different densities

Phosphate levels (PO₄-P) and nitrate (NO₃-N) in sea water fluctuate during the rearing of sea cucumbers in cage (Figure 10). Nitrates in the control area also fluctuate and generally the levels are not much different from the sea water in the karamba.

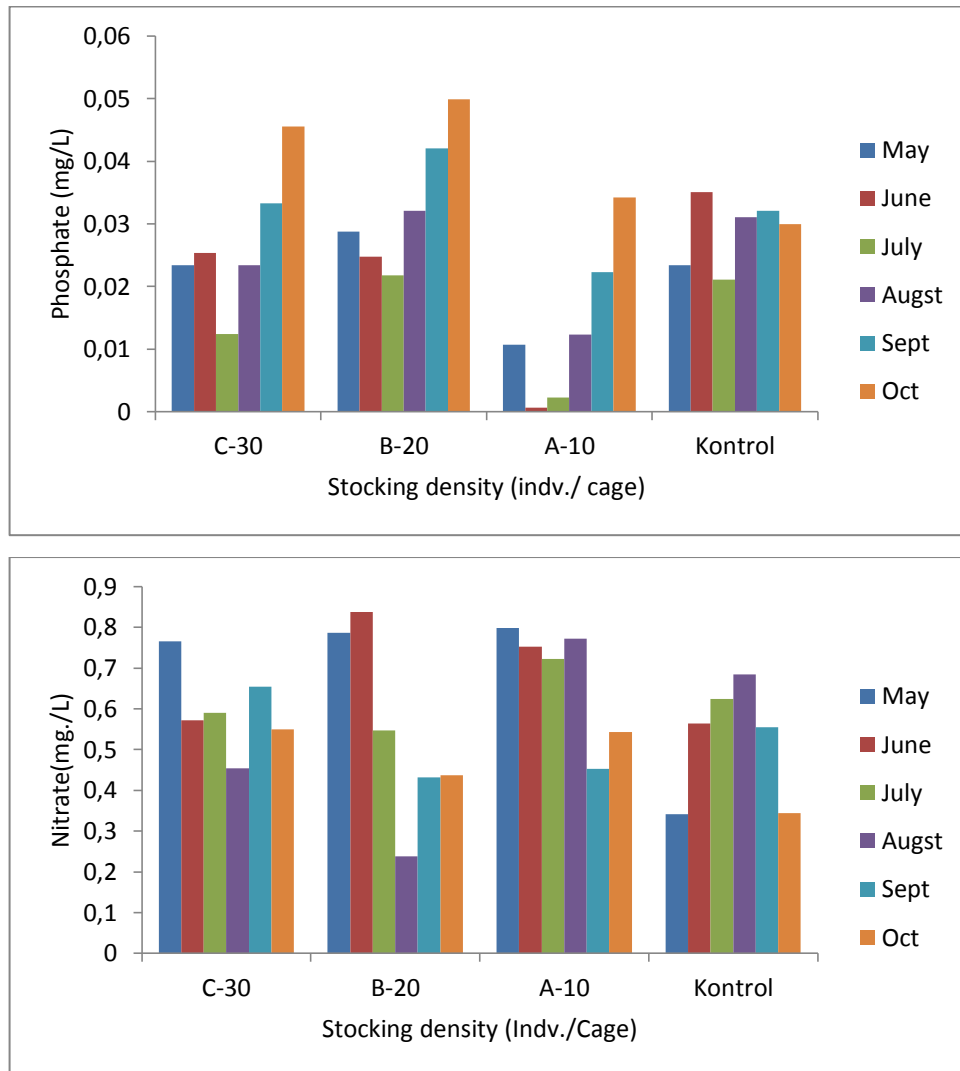

Figure 14. Average phosphate levels (PO₄-P) (A) and nitrate (NO₃-N) (B) (mg / gr) in cage water of *H. atra* reared at different densities

Microphytobentic biomasses which are feeding sources of sea cucumber *H. atra* are measured in the form of chlorophyll-a, chlorophyll-b, chlorophyll-c, phaeophytin and total carotene in sediments, the results of which are shown in Figures 15 and 16.

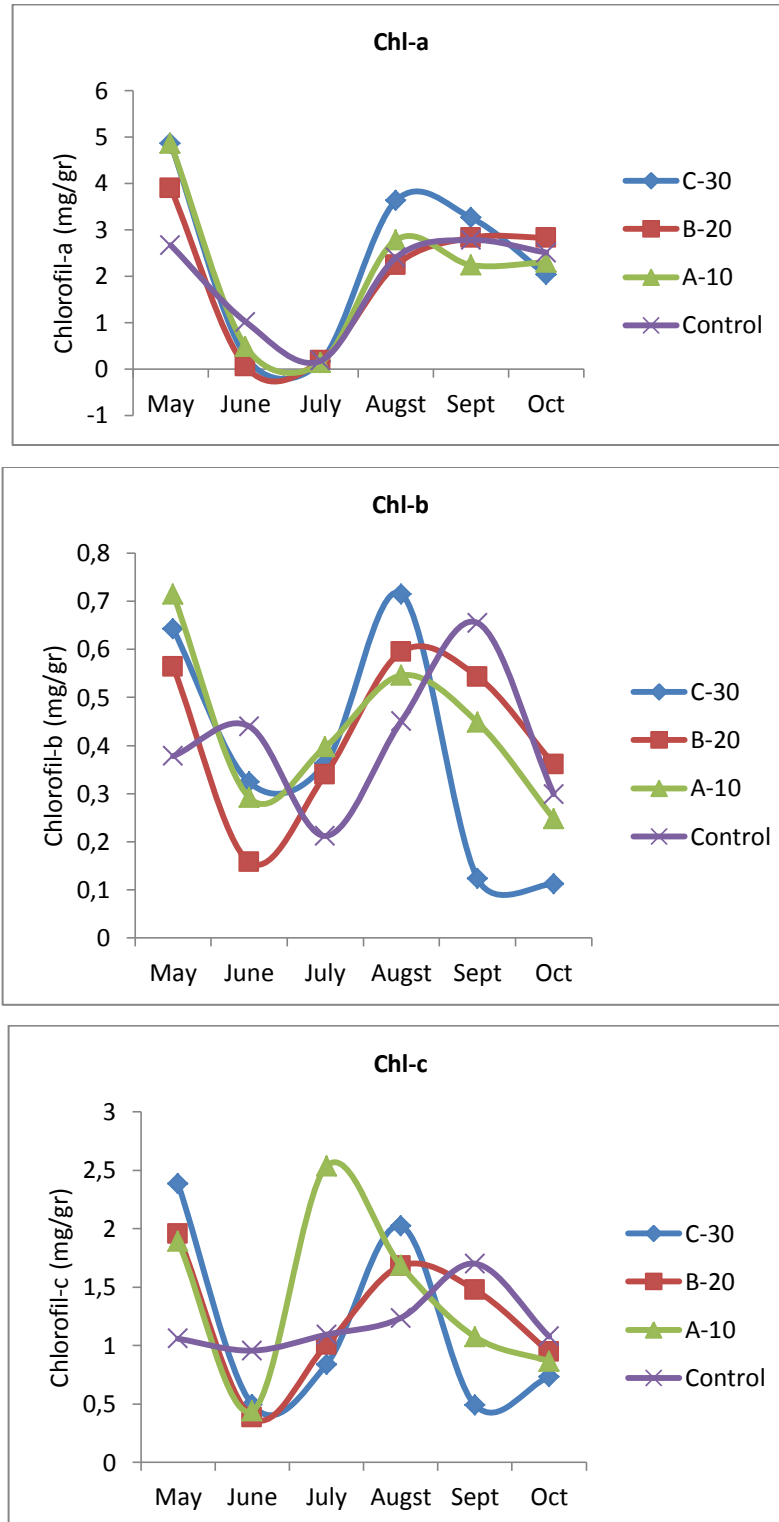

Figure 15. Concentration of chlorophyll-a, chlorophyll-b, and chlorophyll-c, in sediments of sea cucumber *H. atra* cages which are reared at different densities

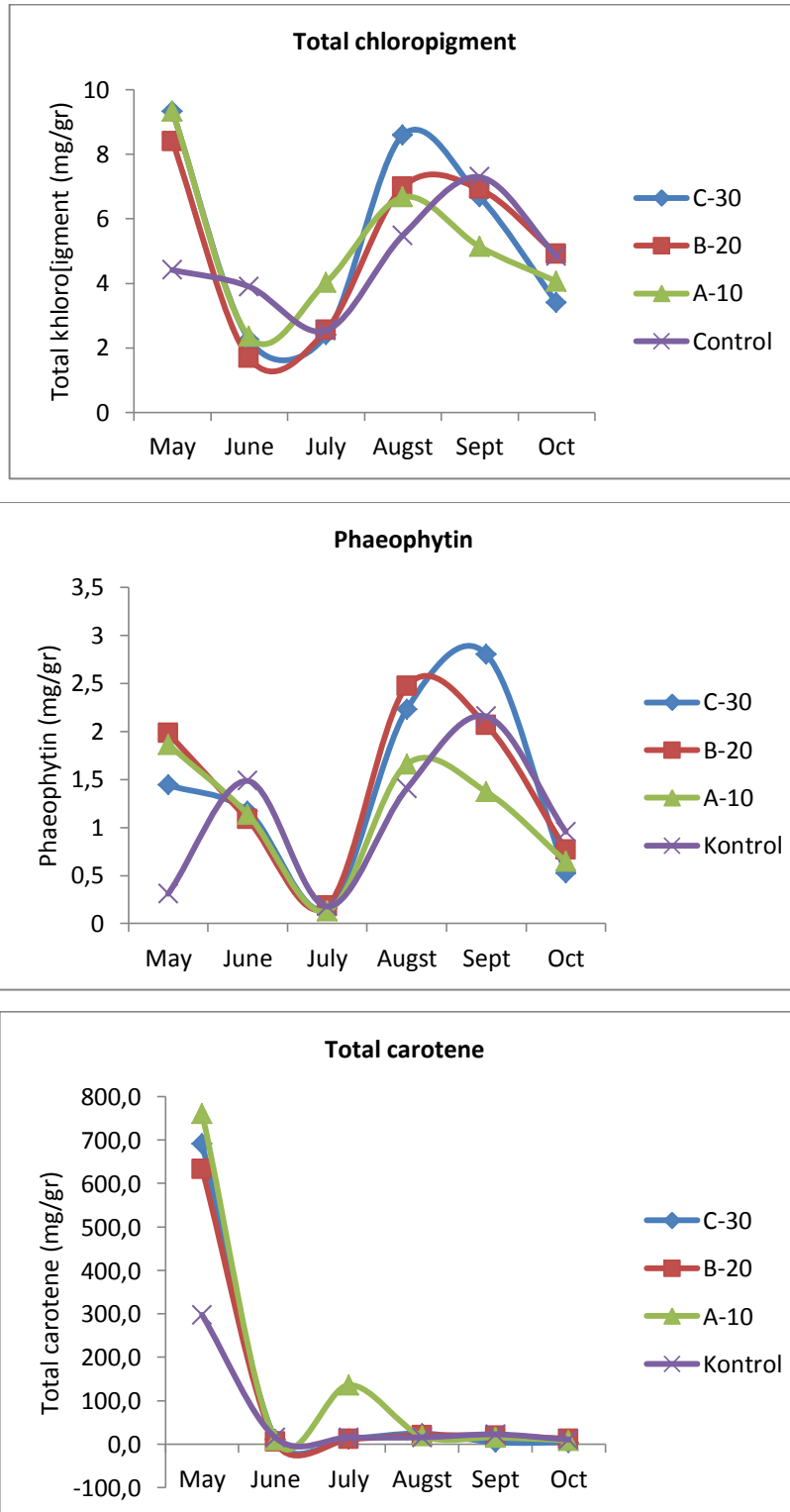

Figure 16. Concentration of total chlorophyll, phaeophytin and total carotene in sediments of sea cucumber *H. atra* cages which are reared at different densities.

Sediment on the bottom of the cage is analyzed for their grain size to see changes in the amount of composition and is presented in Figure 17.

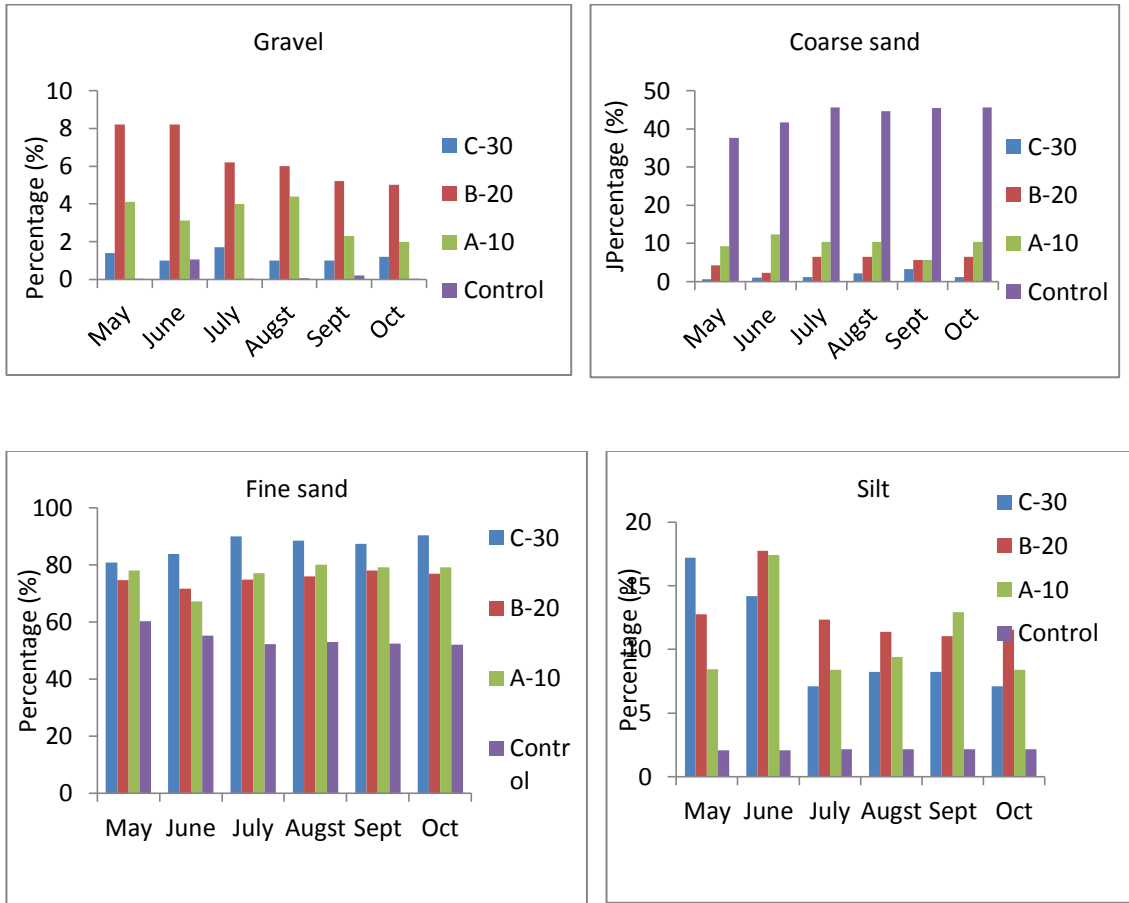

Figure 17. Percentage of gravel, coarse sand, fine sand and silt (%) in cage sediments where sea cucumbers are reared with different stocking densities.

Water quality parameters (temperature, salinity, pH and dissolved oxygen) during rearing of *H. atra* are measured and presented in Figures 18, 19, 20 and 21. Water temperature is considered to be one of the most important parameters affecting the level of growth and development of sea cucumbers and their distribution in the sea. Temperatures in seawaters tend to be stable throughout the study period, which is 28-30°C (Figure 18). The temperature between cage were not significantly different because of the location of cage were closed each others.

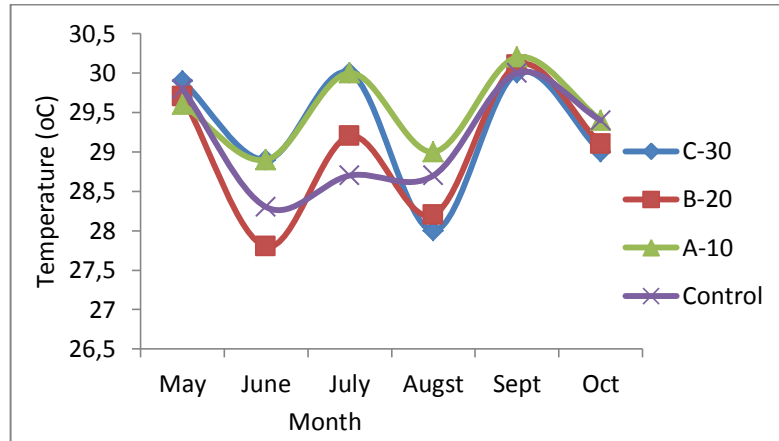

Figure 18. Average Temperature ($^{\circ}\text{C}$) of sea water in *H. atra* rearing cage with different stocking density

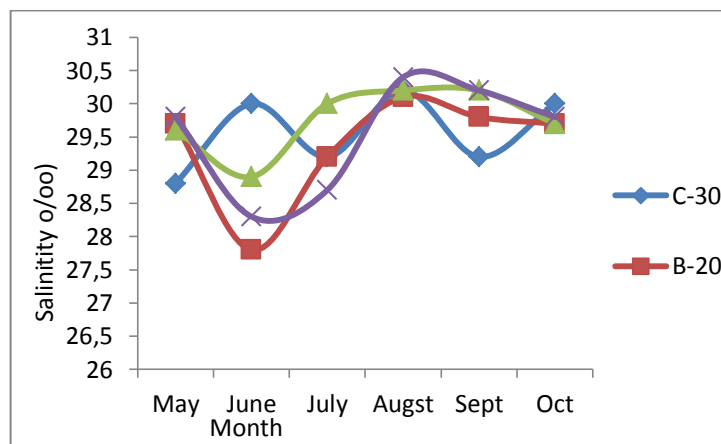

Figure 19. Average salinity (‰) of sea water in *H. atra* rearing cage with different stocking density

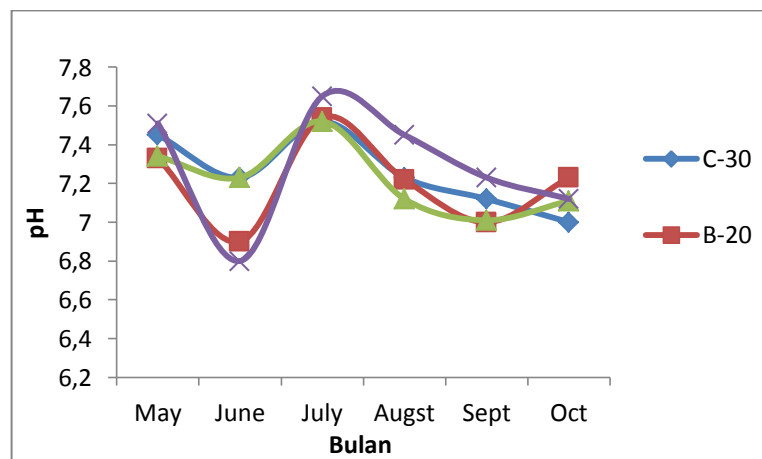

Figure 20. Average pH of sea water in *H. atra* rearing cage with different stocking density

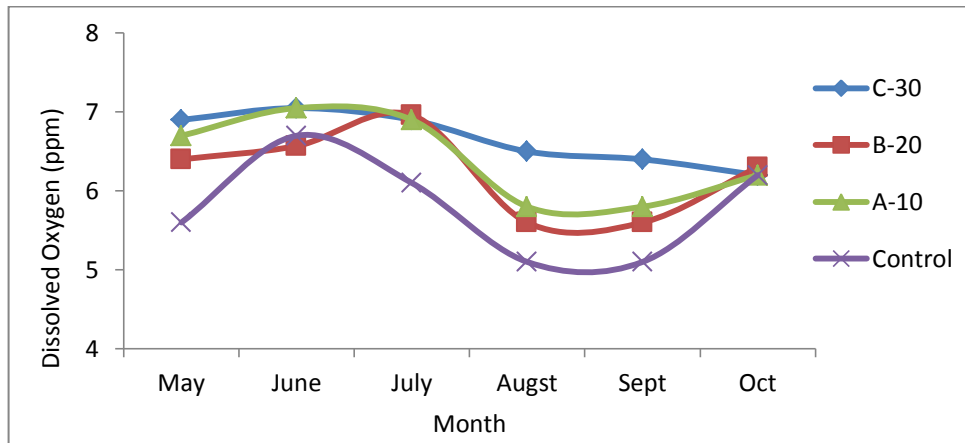

Figure 21. Average dissolved oxygen of sea water in *H. atra* rearing cage with different stocking density

4.2.6. Discussion

Rearing of sea cucumbers in bottom cages has been carried out by Hartati et al. (2009b) and Purcell and Agudo (2013) for *H. scabra* and *S. hermannii* (Hartati et al., 2016). Although according to Chuanxin et al., (2009) the maintenance of sea cucumbers with feeding greatly affects growth performance, i.e. sea cucumbers grow faster when given additional feed but in the process of sea cucumber rearing in this study, *H. atra* were not given additional feed, it was expected that the sediment / substrate is a good habitat to grow feed for sea cucumbers. In sea cucumber maintenance with the aim of sea ranching, no input is given so that the life of sea cucumbers is left to / depend on the availability of natural feed. Therefore choosing the right location is very important to consider.

Sea cucumber growth and survival rate

Stocking density is a very important factor that affects growth in aquaculture. At all times stocking, low stocking density (10 and 20 indiv. / Cage) gives a higher weight than high stocking densities (30 indiv. / cage). The highest increase (19.69 grams) occurred in the stocking of 10 indiv. / Karamba and the lowest (2.1 grams) occurred in the stocking of 30 indiv. / cage. According to Seeruttun et al. (2008) *H. atra* growth depends on density. At high densities there will be accumulation of nitrogenous waste and low oxygen availability after food and space competition. As in the study of Domínguez-Godino and González-Wangüemert (2018) stress due to high stocking density is thought to be a major factor affecting the growth and performance of sea cucumber *H. arguinensis* and *H. mammata*.

According to the results of research by Pei et al. (2012) on *Apostichopus japonicus* stocking density has an adverse effect on sea cucumber growth, not through decreasing water quality or food competition, but through the role of density as an environmental stress factor. The impact of high density also gives a greater variation in body weight, the same thing happened in this study.

Crowding of stress or overcrowding can stimulate the endocrine system of small-sized individuals who increase cortisol levels in coelomic fluid and, in turn, accelerate energy consumption, modify the energy budget model, and ultimately play a negative role in growth and composition biochemistry of these individuals (Pei et al., 2012). It seems that in this study the condition is also lowered by the effects of fission which made the body size smaller. At certain high densities the sea cucumber stops growing. The density value where sea cucumbers cannot grow is called critical biomass value (CBV) and according to Lavitra et al., (2010a) CBV in *H. scabra* is 650 grams / m² so that for ranching purposes density is not exceeded, whereas for juvenile *H. atra* 250-350 gram / m². CBV is strongly influenced by the availability of feed, *H. atra* is a deposit feeder (Conand, 2006a), these sea cucumbers digest organic materials from sediments which continue to decrease during maintenance. Sea cucumbers mainly eat microfitobentic (algal periphyte) (Taddei, 2006) and bacteria (Lavitra, 2010b); and in the presence of sunlight that reaches the bottom of the waters (brightness) will support rapid growth in sea cucumbers (Pitt and Duy, 2004). The results of this study suggest to use the optimum stocking density, to prevent problems such as overcrowding which will cause low growth, a very varied body size, cause deformation of body shape and "rotten stomach" (hard stomach) Seeruttun et al (2008). And in this study overcrowding causes fission which causes slow growth.

Stocking time in general is also influenced the growth of *H. atra* because in the first, second and third stocking of sea cucumbers are reared for 5, 4 and 3 months. For longer rearing (5 months) have less weight gain (2.1-12.52 grams) than second stocking (13.1-19.69 grams) which means that sea cucumbers have been kept for 4 months). The second stocking provides an opportunity for sediments in the cages to be overgrown with microphytobenthic so that the sediments are more readily prepared for sea cucumber habitat than the first stocked ones. At the third stocking, the maintenance duration of 3 months of sea cucumber weight increase ranged from 5.43 to 8.86 grams.

The survival rate of sea cucumbers during rearing in cages were fluctuated. Based on stocking density and stocking time, the survival rate at 30 indiv./cage stocking densities is

higher than other stocking densities. While based on stocking time, the third stocking still provides a high survival rate because it has only been reared for 3 months. The high survival rate is thought to be due to the existence of a fission process that increases the number of more individuals living (Figure 10), but provides smaller individuals (Figure 8). In juvenile *H. atra*, the survival rate is influenced by stocking density (Seeruttun et al., 2008), where fission has not occurred. Fission events in *H. atra* individuals cultivated in cage in marine culture have not been studied so much that there is no comparison with this study.

Fission

Sea cucumbers naturally have great potential to regenerate after the process of evisceration (expell of their internal organs). Evisceration occurs due to physiological changes or in response to various external factors. During evisceration, sea cucumbers secrete a large portion of their internal organs and within a certain period of time they will grow back and live normally (Hartati et al., 2016). Regeneration also occurs after the process of asexual reproduction by fission. This process will produce new individuals with regeneration in the posterior or anterior part.

The process of fission naturally occurs as in Figure 11, there appears to be a narrowing of the part of the body that will divide (Figure 11A). After splitting (fission), a new individual will close the wound in the division section (fission plane) (Figure 11B) and the initial regeneration appears a bulge in the fission plane (Figure 11C). The new growth (regeneration) of the body part is shown in Figure 12. This fission process can provide a high survival rate data (Figure 10), but it will produce smaller sea cucumber individuals (Figure 8).

In this study in general the densely populated population experienced more fission than the non-dense one, but the stocking time did not significantly affect the number of fission individuals (Table 3). According to Asha and Diwakar (2015) and Hartati et al. (2018) fission is a phenomenon that is highly dependent on population density even though Lee et al. (2008) showed that fission in dense and low populations was not significantly different. In nature fission is considered to play a role in maintaining populations in some types of holothurian to compensate for mortality and migration (Chao et al. 1994; Uthicke 2001a).

Water quality parameters

The trend in the concentration of chlorophyll a, b, c, phaeophytin and total carotene is almost the same in all karamba, which is high in the first month, decreases in the second and

third months of sea cucumber rearing and increases in the following month and decreases again in the last month of the study (Figure 15 and 16). Microphytobenthos or benthic microalgae describe as groups of photoautotrophic microorganisms that inhabit the surface layers of sediments of shallow aquatic ecosystems such as diatoms, cyanobacteria and other chlorophytes (Sullivan and Currin 2000). In shallow coastal waters microphytobenthos plays an important role in the metabolic system. They significantly contribute to primary production (Hardiso et al., 2013). They are important food sources for meiofauna such as sea cucumbers (Blanchard, 1991). This prediction will cause fluctuations in concentration as stated by Hartati et al. (2018b). Chlorophyll c is a very sensitive marker of algae containing chlorophyll c biomass (Kowalewska et al., 1996) and the ratio of total chlorophyll c and b to chlorophyll a can be a good indicator of the amount of diatomic and green algal biomass.

According to Slater and Jeffs (2010), bottom sediment characteristics are one of the important components that influence sea cucumber habitat preferences and hence studies of the characteristics of sea cucumber sediment are very important to do. Rocky sediments should be avoided because sea cucumbers live in mud or sand and remain in the organic material in the same place. *H. atra* is a deposit feeder that swallows sediment with organic matter (Michio et al., 2003), and their intestinal contents are dominated by decaying macroalgae and seaweed, shell fragments from molluscs, crustaceans and barnacles, echinoderm ossicles, many pelagic and benthic foraminifers and diatom (Zhang et al., 1995).

Some studies also show that sea cucumbers swallow marine animal feces (Zhou et al., 2006), even their own feces (Kang et al., 2003). Dissanayake and Stefansson (2012) state that in shallow water (<10 m) *H. atra* prefers seagrass habitats with sediments with 15-25% gravel and coarse sand (0.7–1.2 mm) but not mud. The Bellchambers et al. (2011) also found that *H. atra* was mainly in sand-dominated habitats. Preference for specific habitat characteristics seems to be related to their feeding and protection (Hartati et al., 2017).

The effect of sediment quality and stocking density on the survival and growth of sea cucumber *H. scabra* reared in sea-cages was investigated by Lavitra et al. (2010) and found that density gave more effect on growth and survival rate whereas sediment only affects growth that's why it is recommended to add sediments from seagrass beds or select seagrass bed as rearing locations.

In addition to the availability of good quality and quantity of feed, water quality parameters (temperature, salinity, pH and dissolved oxygen content) in the range of good values must also be considered. Water temperature represents the most important aspects of

the environment that affect poikilotherm marine animals, and ocean temperatures vary widely spatially and temporally. Temperature is also one of the most important environmental factors that affect growth and physiological performance in aquatic animals such as sea cucumber *H. atra*. According to several studies of sea cucumber *Apostichopus japonicus*, temperature influences growth (An et al., 2007), immune response (Wang et al., 2008), body composition (Dong et al., 2006), rhythm of activity (Dong et al. (2011) and feeding process and movement of body cucumbers (Sun et al., 2018). During maintenance in May-October 2018, the temperature does not fluctuate much (Figure 14), which ranges from 28-30°C. This result is thought to be the same for the type of sea cucumber *H. scabra* where the water temperature does not affect the survival rate but has more influence on growth with a temperature of more than 30 ° C which gives better growth (Lavitra et al., 2010) which affects their feeding activity Ramofafia et al. (1995) reported optimum temperature for *H. atra* range 27-30 °C The process of aestivation (adaptation to high temperatures) has not been widely discussed in *H. atra*, but usually during the day *H. atra* will cover the body with sand which is thought to be a response to high temperatures.

Sea cucumbers are stenohaline invertebrates that cannot tolerate a wide range of salinity. Therefore river mouths, estuaries and other bays where salinity falls below 10 ppt during the monsoon season should be avoided (James, 1993). Although there is a small river that goes into Teluk Awur waters, it does not affect the salinity around the cages which is 500 meters far from the estuary. Salinity in the Teluk Awur waters is presented in Figure 15, which ranges from 27.5-30.5 ‰ which is still suitable for the life of sea cucumbers.

In addition to temperature and salinity, water pH will affect the life of sea cucumber *H. atra*. pH fluctuations occur seasonally where the dry season is characterized by high water temperatures and low water movements / currents that produce low pH values between 7.3-7.5, while pH increases to 8.4- 8.6 during the rainy season because the entry of high water influx (Gullian and Preciat, 2017). Wittmann and Portner (2013) say that in general, vertebrates have the ability to regulate osmotic pressure and very good acid-base conditions and therefore are better able to cope with changes in pH compared to invertebrates that have lower regulatory capacity, but information about the effect of pH on sea cucumber was very little. According to Asha and Muthiah (2005), temperatures of 28–32°C, salinity 35 ppt and pH 7.8 are optimum conditions for maintenance of *H. spinifera* larvae. In sea cucumbers, *I. badionotus* which is exposed to pH up to 7.70 results in increasing metabolic rate and antioxidant enzyme activity. Epidermal layer in sea cucumber *I. bionotus* is known to be a

very important defense barrier that is activated by changes of environment, especially by the pH of sea water. During maintenance of *H. atra*, pH in cages ranges from 6.8-7.6

Sea cucumber is a deposit feeder that respire with all the tentacles, skin and respiration trees by consuming lots of water and absorbing dissolved oxygen inside. In his research Zamani et al. (2018) found that the limit of hypoxia for *H. leucospilota* was 3 mg O₂ / L wherein the sea cucumber released its cuverian tube to lower its energy needs in its aesthetic process. Furthermore, it is also said that the normal conditions of dissolved oxygen > 6 mg / L provide a 100% survival rate. At maintenance of *A. japonicus*, Liao dissolved oxygen is maintained at > 5 mg / liter (Renbo and Yuan, 2004). Normal oxygen content in coastal waters ranges from 5-8 mg / L (Diaz and Rosenberg 1995). During the rearing period the dissolved oxygen content in the cages ranged from 6-7 mg / L (Figure 17) there were no signs of *H. atra* evisceration due to hypoxia.

5. Conclusions

Black sea cucumbers (*Holothurian atra*) reared in the bottom cage in Teluk Awur waters of Jepara with low stocking densities (10 individuals / cage) produce higher growth and survival rates. Stocking time in the second month after the cages were installed also results in higher growth. Chlorophyll a, b, c, phaeophytin and carotene levels fluctuate according to the time of sea cucumber rearing caused by their feeding and bioturbation activities.

6. References

- An, Z., Y. Dong, and S. Dong. 2007. Temperatur effects on growth-ration relationship of sea cucumber *Apostichopus japonicus* (selenka). *Aquaculture* 272: 644-648.
- Anderson, S.C., Flemming, J.M., Watson, R., Lotze, H.K., 2010. Serial exploitation of global sea cucumber fisheries. *Fish and Fisheries* 12, 317–339.
- Anderson, S.C., Mills-Flemming, J., Watson, R. and Lotze, H.K. 2011. Serial exploitation of global sea cucumber fisheries. *Fish and Fisheries*, 12: 317–339.
- Asha, P.S. and P. Muthiah. 2005. Effects of temperature, salinity and pH on larval growth, survival and development of the sea cucumber *Holothuria spinifera* Theel. *Aquaculture* 250: 823– 829
- Asha P. S. and K. Diwakar. 2015. Field observation of asexual reproduction by fission in sea cucumber *Holothuria atra*. *Mar. Fish. Infor. Serv., T & E Ser.*, 223 & 224: 29-30

- Blanchard, G. F. 1991. Measurements of meiofauna grazing rates on microphytobenthos: is primary production a limiting factor? *J. Expl. Mar. Biol. Ecol.*, 147:37-46.
- Bartley, Devin M., 2007. Responsible stock enhancement, restocking and sea ranching : rational and terminology. Ecosystem-based stock enhancement workshop : development of a road map to evaluate the potential of sea ranching, stock enhancement, restocking programmes within the European multi-national context Provincial Court, Burges, Belgium, 7-8 May 2007.
- Bell, Johann D., Steven W. Purcell, Warwick J. Nash. 2008. Restoring small-scale fisheries for tropical sea cucumbers. *Ocean & Coastal Management* 51: 589–593.
- Bell, J. D., Kenneth M. Leber, H. Lee Blankenship, Neil R. Loneragan, and Reiji Masuda. 2008. A New Era for Restocking, Stock Enhancement and Sea Ranching of Coastal Fisheries Resources Reviews in fisheries science vol. 16 nos. 1–3 2008
- Chao, S.M., Chen, C.P., Alexander, P.S., 1994. Reproduction and growth of *Holothuria atra* (Echinodermata: Holothuroidea) at two contrasting sites in southern Taiwan. *Mar. Biol.* 119, 565–570.
- Choo, P.S., 2008. The Philippines: a hotspot of sea cucumber fisheries in Asia. In: ToralGranda, V., Lovatelli, A., Vasconcellos, M. (Eds.), *Sea Cucumbers. A Global Review of Fisheries and Trade*. FAO Fisheries Technical Paper 516. FAO, Rome, pp. 119–140.
- Chuanxin, Q., D. Shuanglin, T. Fuyi, T. Xiangli, W. Fang, D. Yunwei, G. Qinfeng. 2009. Optimization of Stocking Density for the Sea Cucumber, *Apostichopus japonicus* Selenka, Under Feed-Supplement and Non-Feed-Supplement Regimes in Pond Culture. *J. Ocean Univ. China* (Oceanic and Coastal Sea Research). 8 (3): 296-302 DOI 10.1007/s11802-009-0296-1
- Conand, C., 2004. Present status of world sea cucumber resources and utilization: an international overview. Workshop on Advances in Sea Cucumber Aquaculture Management, Dalian (China), 14–18 Oct 2003
- Conand C. 2006a Sea cucumber biology: Taxonomy, distribution, biology, conservation status. In: Bruckner AW (eds) Proceedings of the CITES workshop on the conservation of sea cucumbers in the families Holothuridae and Stichopodidae. NOAA Technical Memorandum NMFSOPR 34, Silver Spring. pp 30-46
- Conand, C., 2008. Population status, fisheries and trade of sea cucumbers in Africa and the Indian Ocean. In: Toral-Granda, V., Lovatelli, A., Vasconcellos, M. (Eds.), *Sea Cucumbers. A Global Review of Fisheries and Trade*. FAO Fisheries Technical Paper 516. FAO, Rome, pp. 143–193
- Diaz, R.J. & Rosenberg, R. (1995) Marine benthic hypoxia: A review of its ecological effects and the behavioural responses of benthic macrofauna. *Oceanogr Mar Biol* **33**, 245-303

- Dissanayake, DCT., and G. Stefansson. 2012. [Habitat preference of sea cucumbers: *Holothuria atra* and *Holothuria edulis* in the coastal waters of Sri Lanka](#). *J. of the Mar. Biol. Ass. of the UK*. 92(3): 581-590
- Domínguez-Godino, J.A. and González-Wangüemert, M. 2018. Does space matter? Optimizing stocking density of *Holothuria arguinensis* and *Holothuria mammata*. *Aquaculture Research* DOI: 10.1111/ARE.13773
- Domínguez-Godino, Jorge A., Matthew J. Slater, Colin Hannon, Mercedes González-Wangüemert. 2015. A new species for sea cucumber ranching and aquaculture: Breeding and rearing of *Holothuria arguinensis*. *Aquaculture* 438 (2015): 122–128.
- Dong, Y., S. Dong, X. Tian and F. Wang. 2006. Effects of diel temperature fluctuations on growth, oxygen consumption and proximate body composition in the sea cucumber *Apostichopus japonicus* (selenka). *Aquaculture* 255: 514-521.
- Dong, G., S. Dong, X. Tian and F. Wang. 2011. Effects of photoperiod on daily activity rhythm of juvenile sea cucumber *Apostichopus japonicus* (selenka). *Chin. J. Ocnol. Lim.* 29:1015-1022.
- Eriksson, H., Robinson, G., Slater, M.J., Troell, M., 2012. Sea cucumber aquaculture in the western Indian Ocean: challenges for sustainable livelihood and stock improvement. *AMBIO: A Journal of the Human Environment*: 41, 109–121.
- Gullian, K.M, and T.M. Preciat. 2017. Effect of pH on temperature controlled degradation of reactive oxygen species, heat shock protein expression, and mucosal immunity in the sea cucumber *Isostichopus badionotus*. *PLoS ONE* 12(4): e0175812. <https://doi.org/10.1371/journal.pone.0175812>
- Hardiso, A.K., E.A. Canuel, I.C. Anderson, C.R. Tobias, B. Veuger, and M.N. Waters. 2013. Microphytobenthos and benthic macroalgae determine sediment organic matter composition in shallow photic sediments. *Biogeosciences*, 10: 5571–5588. www.biogeosciences.net/10/5571/2013/. doi:10.5194/bg-10-5571-2013
- Hartati, R., Widianingsih, D. Pringgenies. 2002. Teknologi Pembenihan Teripang Putih (*Holothuria scabra*): Pemeliharaan Juvenil. Laporan Penelitian Hibah Bersaing IX Tahun ke 2 Lemlit UNDIP, 67 hal.
- Hartati, R., Widianingsih, D. Pringgenies. 2005. Teknologi penyediaan pakan bagi teripang putih (*Holothuria scabra*). Laporan Penelitian Hibah Bersaing XII Tahun ke 2 Lemlit UNDIP, 48 hal.
- Hartati, R., Widianingsih, Pradina Purwati. 2009a. Teripang (Holothuroidea : Echinodermata) di Indonesia : Biologi, Budidaya dan Konservasinya. Penerbit Navila Idea. Yogyakarta. 72 hal

- Hartati, R., Widianingsih, Delianis Pringgenies. 2009b. Pembenuhan dan pembesaran Teripang Pasir (Echinodermata: Holothuroidea). Badan penerbit Universitas Diponegoro. Semarang. 128 hal.
- Hartati, R., P. Purwati dan Widianingsih. 2015. Field Guide. Timun Laut. Pohon Cahaya. Yogyakarta, 37 halama,
- Hartati, R., Widianingsih dan Hadi Endrawati. 2016. The Growth of Sea cucumber *Stichopus herrmanni* After Transverse Induced Fission in Two and Three Fission Plane. *Ilmu Kelautan IJMS Indonesian Journal of Marine Science* 21(2) : 93-100
- Hartati, R., A. Trianto, and Widianingsih , 2017a. Habitat characteristic of two selected locations for sea cucumber ranching purposes. 2017 IOP Conf. Ser.: Earth Environ. Sci. 55 012041 (<http://iopscience.iop.org/1755-1315/55/1/012041>)
- Hartati, R., Widianingsih, A. Trianto, M. Zainuri, Ambariyanto. 2017b. The abundance of prospective natural food for sea cucumber *Holothuria atra* at Karimunjawa Island waters, Jepara, Indonesia. *BIODIVERSITAS* 18(3): 947-953
- Hartati, R. M. Zainuri, A. Ambariyanto, F.P. Ayodya, W. Widianingsih, M. Mustagfirin. 2018a. Initial assesment of *Holothuria atra* population in Panjang Islands. The 1st International Conference on Fisheries and Marine Science. Universitas Airlangga Surabaya, 6th October 2018.
- Hartati, R., A. Ambariyanto, M. Zainuri, W. Widianingsih, E. Supriyo, A. Trianto. 2018b. The concentration of chlorophyll-c in the bottom sediment of sea cucumber rearing cage. The 4nd International Conference on Tropical and Coastal Region Eco Development 2018. Semarang, 30-31 October 2018.
- Kang, K.H., Kwon, J.Y., Kim, Y.M., 2003. A beneficial coculture: charm ablone *Haliotis discus* Hannai and sea cucumber *Stichopus japonicus*. *Aquaculture* 216: 87–93
- Kinch, J., Purcell, S., Uthicke, S., Friedman, K., 2008. Population status, fisheries and trade of sea cucumbers in the Western Central Pacific. In: Toral-Granda, V., Lovatelli, A., Vasconcellos (Eds.), *Sea Cucumbers: A Global Review of Fisheries and Trade*. FAO Fisheries and Aquaculture Technical Paper 516. FAO, Rome, pp. 7–55
- Kowalewska, G., A. Witkowski., B. Toma. 1996. Chlorophylls *c* in bottom sediments as markers of diatom biomass in the southern Baltic Sea. *OCEANOLOGIA*, 38(2): 227–249.
- Lavitra T, Fohy N, Gestin P, Rasolofonirina R, Eeckhaut I. 2010b. Effect of water temperature on the survival and growth of endobenthic *Holothuria scabra* (Echinodermata: Holothuroidea) juveniles reared in outdoor ponds. *SPC, Bêche-de-mer Bulletin* 30: 25-28
- Lavitra, T., R. Rasolofonirina, I. Eeckhaut. 2010a. The Effect of Sediment Quality and Stocking Density on Survival and Growth of the Sea Cucumber *Holothuria scabra* Reared in Nursery Ponds and Sea Pens. *Western Indian Ocean J. Mar. Sci. Vol. 9, No. 2*, pp. 153-164, 2010

Lavitra, T., N. Fohy, P. Gestin, R. Rasolofonirina and I. Eeckhaut. 2010b. Effect of water temperature on the survival and growth of endobenthic *Holothuria scabra* (Echinodermata: Holothuroidea) juveniles reared in outdoor ponds. SPC Beche-de-mer Information Bulletin #30:25-28.

Lee, J., M. Byrne, S. Uthicke 2008b The influence of population density on fission and growth of *Holothuria atra* in natural mesocosms Journal of Experimental Marine Biology and Ecology 365 (2008) 126–135

Lovatelli A., Conand C, Purcell S, Uthicke S, Hamel JF, Mercier A., editors. 2004. Advances in sea cucumber aquaculture and management. FAO fisheries technical paper no. 463. Rome: United Nations Food and Agriculture Organisation.

Michio, K., Kengo, K., Yasunori, K., Hitoshi, M., Takayuki, Y., Hideaki, Y., Hiroshi, S., 2003. Effects of deposit feeder *Stichopus japonicus* on algal bloom and organic matter contents of bottom sediments of the enclosed sea. Mar. Pollut. Bull. 47: 118–125.

Palmegiano, G.B., F. Daprà, G. Forneris, F. Gai, L. Gasco, K. Guo, P.G. Peiretti, B. Sicuro, I. Zoccarato. 2006. Rice protein concentrate meal as a potential ingredient in practical diets for rainbow trout (*Oncorhynchus mykiss*). *Aquaculture*, 258(1): 357-367

Pei, S., [S. Dong](#), [F. Wang](#), [X. Tian](#), [Q. Gao](#) 2012. Effects of density on variation in individual growth and differentiation in endocrine response of Japanese sea cucumber (*Apostichopus japonicus* Selenka). [Aquaculture 356-357](#) : 398-403
DOI [10.1016/j.aquaculture.2012.04.032](#)

Pitt R, and Duy NDQ. 2004. Breeding and rearing of the sea cucumber *Holothuria scabra* in Viet Nam. In: Lovatelli A, Conand C, Purcell S, Uthicke S, Hamel JF, Mercier A. (eds) Advances in sea cucumber aquaculture and management. Fisheries Technical Paper No 463, FAO, Rome. pp 333-346

Polidoro, B., Tognelli, M., Harwell, H., 2011. IUCN Red List workshop for sea cucumbers. SPC Beche-de-mer Information Bulletin 31, 65.

Purcell SW, and NS Agudo, 2013. Optimisation of Mesh Enclosures for Nursery Rearing of Juvenile Sea Cucumbers. PLoS ONE 8(5): e64103.
<https://doi.org/10.1371/journal.pone.0064103>

Purcell, S.W., Lovatelli, A., Vasconcellos, M., Ye, Y., 2010. Managing sea cucumber fisheries with an ecosystem approach. In: Lovatelli, A., Vasconcellos, M., Yimin, Y. (Eds.), FAO Fisheries and Aquaculture Technical Paper No. 520. FAO, Rome.

Purcell, S.W., Hair, C.A., Mills, D.J., 2012a. Sea cucumber culture farming and sea ranching in the tropics: progress problems and opportunities. *Aquaculture* 368, 68–81.
<http://dx.doi.org/10.1016/j.aquaculture.2012.08.053>.

Purcell, S.W., Mercier, A., Conand, C., Hamel, J.F., Toral-Granda, M.V., Lovatelli, A., Uthicke, S., 2012b. Sea cucumber fisheries: global analysis of stocks management measures

and drivers of overfishing. *Fish Fish.* 14, 34–59. <http://dx.doi.org/10.1111/j.1467-2979.2011.00443.x>.

Purcell, S.W., Samyn, Y., Conand, C., 2012c. Commercially Important Sea Cucumbers of the World. FAO Species Catalogue for Fishery Purposes No. 6. FAO, Rome, p. 150.

Purcell, Steven W., Cathy A. Hair, David J. Mills. 2012d. Sea cucumber culture, farming and sea ranching in the tropics: Progress, problems and opportunities. *Aquaculture* 368–369: 68–81.

Purwati, P., R. Hartati dan Widianingsih. 2012. Eighteen Sea Cucumber Species Fishes in Karimun Jawa Island, Java Sea. *Mar. Res. Indonesia* 35(2): 23-30

Ramofafia, C., Gervis, M., Bell, J., 1995. Spawning and early larval rearing of *Holothuria atra*. SPC Beche-de-mer Inf. Bull.7: 2– 7.

Renbo, W. and C. Yuan. 2004. Breeding and culture of the sea cucumber, *Apostichopus japonicus*, Liao . in A. Lovatelli, C. Conand, S. Purcell, S. Uthicke, J-F. Hamel, A. Mercier (Eds.) Advances in sea cucumber aquaculture and management FAO Fisheries Technical Paper 463

Seeruttun, R., C. Appadoo, A. Laxminarayana & B. Codabaccus. 2008. A Study on the Factors Influencing the Growth and Survival of Juvenile Sea Cucumber, *Holothuria atra*, under Laboratory Conditions. University of Mauritius Research Journal 14 :1-15

Slater, M. J. and Jeffs, A. G. 2010. Do benthic sediment characteristics explain the distribution of juveniles of the deposit-feeding sea cucumber *Australostichopus mollis*? *J. Sea Res.*, 64: 241–249

Sullivan MJ, and CA Currin. 2000 Community structure and functional dynamics of benthic microalgae in salt marshes. In: Weinstein MP, Kreeger DA (eds) Concepts and controversies in tidal marsh ecology. Kluwer Academic Publishers, Dordrecht, p 81–106

Sun, J., L. Zhang, Y. Pan, C. Lin, F. Wang and H. Yang. 2018. Effect of water temperature on diel feeding, locomotion behavior and digestive physiology in the sea cucumber *Apostichopus Japonicus*. *Journal of Experimental Biology* (2018) 221, jeb177451. doi:10.1242/jeb.177451

Taddei, D. 2006. Transfert de matière et d'énergie dans les sédiments d'un complexe récifal anthropisé (Ile de la Réunion, Océan Indien). [Thèse] Université de la Réunion, U.F.R. Sciences et Technologies. 229 pp.

Tian, F., Zhang, X., Tong, Y., Yi, Y., Zhang, S., 2005. A new sulfated saponin from sea cucumber, exhibits anti-angiogenic and antitumor activities in vivo and in vitro. *Cancer Biol. Ther.* 4, 874–882.

Uthicke, S., 2001a. Influence of asexual reproduction on the structure and the dynamics of *Holothuria (Halodeima) atra* and *Stichopus chloronotus* populations of the Great Barrier Reef. *Mar. Freshw. Res.* 52: 205–215

Uthicke S. 2004. Overfishing of holothurians: lessons from the Great Barrier Reef. In: Lovatelli A, Conand C, Purcell S, Uthicke S, Hamel JF, Mercier A, (eds.). Advances in sea cucumber aquaculture and management. FAO fisheries technical paper no. 463. Rome: United Nations Food and Agriculture Organisation. p. 163–71.

Wang, F., H. Yang, F. Gao, and G. Liu. 2008. Effects of acute temperature or salinity stress on the immune response in sea cucumber *Apostichopus japonicus*. *Comp. Biochem. Physiol. A Mol. Integr. Physiol.* 151: 491-498.

Wiadnyana, N.N., Reny Puspasari dan Ralph Thomas Mahulette. 2009. Status sumber daya dan perikanan teripang di Indonesia : pemanfaatan dan perdagangan. *Jurnal kebijakan perikanan Indonesia* 1(1): 45-60

Wittmann, AC, and HO. Portner. 2013. Sensitivities of extant animal taxa to ocean acidification. *Nat Clim Change*.3: 995±1001

Xie, X., W. Zhao, M. Yang. 2013. Combined influence of water temperature, salinity and body size on energy budget in the sea cucumber *Apostichopus japonicus* Selenka. *Fish Sci.*, 79: 639-646.

Zamani, N.P., K. Assidqi and H. Madduppa. 2018. Study of the Tolerance of Black Sea Cucumber *Holothuria leucospilota* to Hypoxia Stress. *Pertanika J. Trop. Agric. Sc.* 41 (3): 1511 - 1521

Zhang, B.L., Sun, D.L., Wu, Y.Q., 1995. Preliminary analysis on the feeding habit of *Apostichopus japonicus* in the rocky coast waters off Lingshan Island. *Mar. Sci.* 3: 11–13 (in Chinese, with English abstract).

Zhou, Y., Yang, H.S., Liu, S.L., Yuan, X.T., Mao, Y.Z., Liu, Y., Xu, X.L., Zhang, F.S., 2006. Feeding and growth on bivalve biodeposits by the deposit feeder *Stichopus japonicus* Selenka (Echinodermata: Holothuroidea) co-cultured in lantern nets. *Aquaculture* 256:510–520

Zonghe, Y., Z. Y. Zhou, H. Yang, Y. Mae, C. Hu. 2014. Survival, growth, food availability and assimilation efficiency of the sea cucumber *Apostichopus japonicus* bottom-cultured under a fish farm in southern China. *Aquaculture*, 426-427: 238-248

Sea Ranching of *Holothuria atra*: Effect of Stocking Density and Stocking Time

ABSTRACT

Strong market demand and uncontrolled exploitation and/or inadequate fisheries management have caused many stocks of sea cucumbers overexploited. One suggested effort to overcome this problem is sea ranching. Stocking density are the most important in sea cucumber rearing, therefore this present work is aimed to seek best stocking density for sea ranching of *Holothuria atra*. *H. atra* is taken from Panjang Jepara Island waters and reared in the bottom cages in Teluk Awur waters, Jepara with a density of 30, 20, 10 individuals per cages measuring of 2 x 2 x 1.8 meter³. *H. atra* were stocked when the cage installed, second and month after installed. Sediment and marine characteristics of sea cucumber habitat in cages were measured during the study. The results showed that growth *H. atra* were fluctuated, low stocking density gave higher weight gain than high stocking density. The highest weight gain was obtained in the density of 10 individu/cages in second stocking. The highest survival rate of *H. atra* was stoked at 30 indiv./ cages (93%) in the 3rd stocking, which means that sea cucumbers were only reared for 3 months. The highest mortality occurred at a density of 20 indiv. / cages so that the survival rate is low (45%) in the 1st stocked, or in the 5th month of rearing. There was fission evidence among *H. atra* reared in the cages, it result in smaller individu. Among the water quality parameters, the concentration of chlorophyll a, b, c, phaephytin and carotene fluctuate according to the time of sea cucumber rearing caused by their feeding and bioturbation.

Keywords: growth, survival, chlorophyll, fission, sediment

INTRODUCTION

In the recent decades, invertebrate fisheries have expanded in catch and value worldwide [1]. One increasingly harvested marine invertebrates group is sea cucumbers. In Indonesia, sea cucumber is called Teripang, trepang, Timun Laut or gamat [2]. Strong market demand and uncontrolled exploitation and/or inadequate fisheries management have led to many sea cucumber stocks becoming heavily overfished [3]. One effort suggested to overcome this problem is sea ranching.

Sea ranching is essentially a 'put and take' activity, where cultured or wild juveniles are released into an area of natural habitat and harvested when they reach a commercially optimal size [4][5]. There are some advantage of sea ranching i.e. inputs are nominally lower, as the processes between release and harvest are largely left to nature and the level of care that can be offered to sea cucumber throughout the growth process is reduced, yet still able to produce marketable size of sea cucumber. However, no published work is available on sea ranching of sea cucumber in Indonesia. Therefore, with the special objectives to avoid overexploitation of natural populations, it is needed a research on sea ranching of sea cucumber. This research will also be able to provide knowledge for a better understanding and application in marine conservation, population genetics and connectivity patterns

A recent trend by fishers in Indonesia is to grow-out wild sea cucumbers in sea pens, this provides a way to restore the damaged fisheries without having to formalise no-take zones or establish fishing rights for sea cucumbers. In the case of sandfish, [4] said that this simple way would involve just one additional activity by fishers: rearing sea cucumbers harvested from the wild in sea pens until marketable size. Some of the key researchable knowledge gaps in restocking of tropical sea cucumbers derived from [6] which will be conducted in this research are optimal habitats for release into sea pens or for sea ranching, suitable stocking densities in the sea as a function of habitat features, effects of behavioural conditioning and acclimation on post-release survival of juveniles and strategies for improving governance and communication as establishment sea cucumber restocking.

As it has been gathered by [7], the recent published data and unpublished data from mariculture programmes on sea cucumber in the Indo-Pacific that provide hatchery production, use of juveniles (for experimental, sea or pond farming, sea ranching, and stock enhancement), and proponents information, none was came from Indonesia. This might due to lack of international publication on sea cucumber research in Indonesia. More over, in the side of conservation area, no published work is available on sea ranching of sea cucumber in Indonesia. With the declining natural stock of sea cucumber [2], it is urgent to conduct works on sea cucumber sea ranching for continuation production and conservation.

Here we proposed sea ranching for *Holothuria atra* because they provide protein sources for human food, bioactive molecules for marine pharmaceutical, ecologically important for their sedimen bioturbation and remineralization and also they have reproduction specific. i.e. asexual reproduction through natural fission.

Stocking density is a very important factor that affects growth in aquaculture. Therefore the objectives of this study is to determine best stocking density for sea cucumber *H. atra* ranching.

METHODS

Teripang hitam (Black Sea cucumber, *Holothuria atra*) (180 individu) were taken from Panjang Island Waters, Jepara, size of 100-150 grams as been used by [8] 9] dan [10]. *H. atra* were reared in the bottom cages measuring of 2 x 2 x 1.8 meter³ installed in Teluk Awur waters, Jepara with geographyc position of 06° 37 '43.8 "S and 110° 38' 31.7" E. It has been found a

suitable location for cage of *H. atra*, which is with a muddy sand substrate, there are seagrasses and seaweed.

Stocking densities applied were 30, 20, 10 individuals per cages with different stocking time i.e. stocked when the cage were installed (A), the second (B) and third (C) month after the cages were installed.

The performance of sea cucumber stocked were determined by their survival rate and growth. The stocking density is assumed affect the behaviour performance due to competition of area and feeding. The sea cucumber were measured their length and weight monthly.

The samples of bottom sediment were taken monthly for microphytobenthic organism though their photosynthesis pigment (chlorophyll-a, -b, -c. phaeophytin and carotene). Physical parameter measured will be temperature, salinity, pH and dissolved oxygen.

The growth rate (Weight gain) were calculated as follows :

$$\text{Weight Gain} = W_2 - W_1$$

$$W_1 = \text{Weight of } H. \text{ atra at } T_{n-1} \text{ (gram)}$$

$$W_2 = \text{Weight of } H. \text{ atra at } T_n \text{ (gram)}$$

Survival rate were calculated as follows.

$$\text{SR (\%)} = (N_t / N_0) \times 100 \%$$

$$N_t = \text{Number sea cucumber alive at } T_n$$

$$N_0 = \text{Number sea cucumber stocked at } T_0$$

RESULTS AND DISCUSSION

Rearing of sea cucumbers in bottom cages has been carried out by [11] and [12] for *H. scabra* and *S. hermannii* [13]. Although according to [14] the maintenance of sea cucumbers with feeding greatly affects growth performance, i.e. sea cucumbers grow faster when given additional feed but in the process of sea cucumber rearing in this study, *H. atra* were not given additional feed, it was expected that the sediment/substrate is a good habitat to grow feed for sea cucumbers. In sea cucumber maintenance with the aim of sea ranching, no input is given so that the life of sea cucumbers is left to/depend on the availability of natural feed. Therefore choosing the right location is very important to consider.

During the rearing, *H. atra*'s weight were measured in the beginning of the study and every month until the study is completed. The increase in weight of sea cucumbers seems to be influenced by the time of stocking and stocking density. Stocking on the second month after the bottom cage is installed seems to be better than the other time of stocking. Likewise a high stocking density affects the weight of the reared sea cucumber. The graph of the average weight of sea cucumber *H. atra* each month is shown in Figure 1.

Growth calculated based on weight gain of sea cucumber *H. atra* at the end of the study were fluctuated, where low stocking density gave greater weight gain than high stocking densities. The highest increase was obtained in the density of 10 individuals / cages in the second stocking. The lowest weight gain in the stocking of 30 individuals/cages at the first stocking (Figure 2).

Stocking density is a very important factor that affects growth in aquaculture. At all times stocking, low stocking density (10 and 20 indiv./Cage) gives a higher weight than high stocking densities (30 indiv./ cage). The highest increase (19.69 grams) occurred in the stocking of 10 indiv./cage and the lowest (2.1 grams) occurred in the stocking of 30 indiv./cage. According to [15] *H. atra* growth depends on density. At high densities there will be accumulation of nitrogenous waste and low oxygen availability after food and space competition. As in the study of [16] stress due to high stocking density is thought to be a major factor affecting the growth and performance of sea cucumber *H. arguinensis* and *H. mammata*. According to the results of research by [17]

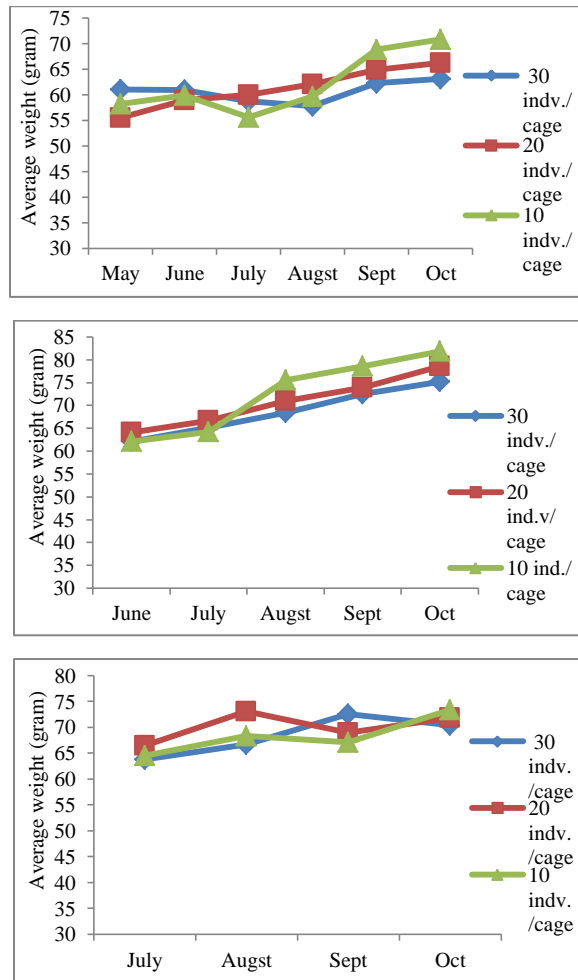

Figure 1. Average weight of sea cucumber *Holothuria atra* reared at different stocking times and densities (A = stocking at month 0 from the start of installation of bottom cages, B = month 1 after cages is installed, and C = month 2 after cages installed)

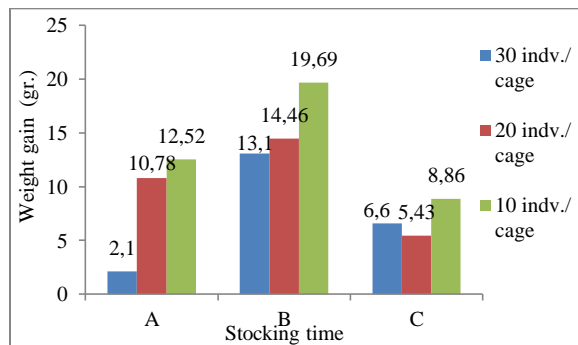

Figure 2. Growth of weight of sea cucumber *Holothuria atra* reared at different stocking times and densities in the end of experiments (A = stocking at month 0 from the start of installation of bottom cages, B = month 1 after cages is installed, and C = month 2 after cages installed)

on *Apostichopus japonicus* stocking density has an adverse effect on sea cucumber growth, not through decreasing water quality or food competition, but through the role of density as an environmental stress factor. The impact of high density also gives a greater variation in body weight, the same thing happened in this study.

Crowding of stress or overcrowding can stimulate the endocrine system of small-sized individuals who increase cortisol levels in coelomic fluid and, in turn, accelerate energy consumption, modify the energy budget model, and ultimately play a negative role in growth and composition biochemistry of these individuals [17]. It seems that in this study the condition is also lowered by the effects of fission which made the body size smaller. At certain high densities the sea cucumber stops growing. The density value where sea cucumbers cannot grow is called critical biomass value (CBV) and according to [18] CBV in *H. scabra* is 650 grams/m² so that for ranching purposes density is not exceeded, whereas for juvenile *H. atra* 250-350 gram / m². CBV is strongly influenced by the availability of feed, *H. atra* is a deposit feeder [19], these sea cucumbers digest organic materials from sediments which continue to decrease during maintenance. Sea cucumbers mainly eat microfitobentic (algal periphyte) [20] and bacteria [21]; and in the presence of sunlight that reaches the bottom of the waters (brightness) will support rapid growth in sea cucumbers [22]. The results of this study suggest to use the optimum stocking density, to prevent problems such as overcrowding which will cause low growth, a very varied body size, cause deformation of body shape and "rotten stomach" (hard stomach) [15]. And in this study overcrowding causes fission which causes slow growth.

Stocking time in general is also influenced the growth of *H. atra* because in the first, second and third stocking of sea cucumbers are reared for 5, 4 and 3 months. For longer rearing (5 months) have less weight gain (2.1-12.52 grams) than second stocking (13.1-19.69 grams) which means that sea cucumbers have been kept for 4 months). The second stocking provides an opportunity for sediments in the cages to be overgrown with microphytobenthic so that the sediments are more readily prepared for sea cucumber habitat than the first stocked ones. At the third stocking, the maintenance duration of 3 months of sea cucumber weight increase ranged from 5.43 to 8.86 grams.

The number of sea cucumber *H. atra* that lives at the end of the study is different based on the stocking density. Fluctuations in the number of sea cucumbers occurred, which when calculated based on the survival rate became uncommon because they exceeded 100% (occurring in 10 individu/cage stocking densities, 3rd stocking in September). This occurs because of the phenomenon of fission (asexual reproduction) in sea cucumbers which are reared in cages. The survival of sea cucumbers which are stocked on dense stockings and different stocking times during maintenance is shown in Figure 3.

The highest survival rate of *H. atra* at the end of the study occurred in 30 indiv./cage stocking densities, which was 93% in the 3rd stocking, which means that sea cucumbers were maintained for 3 months. The highest mortality occurred at a density of 20 indiv./cage so that the survival rate is low (45%) in the 1st stocked, or in the 5th month of rearing. The survival rate results are presented in Figure 4.

The survival rate of sea cucumbers during rearing in cages were fluctuated. Based on stocking density and stocking time, the survival rate at 30 indiv./cage stocking densities is higher than other stocking densities. While based on stocking time, the third stocking still provides a high survival rate because it has only been reared for 3 months. The high survival rate is thought to be due to the existence of a fission process that increases the number of more individuals living (Figure 10), but provides smaller individu (Figure 8). In juvenile *H. atra*, the survival rate is influenced by stocking density [15], where fission has not occurred. Fission events in *H. atra* individuals cultivated in cage in marine culture have not been studied so much that there is no comparison with this study.

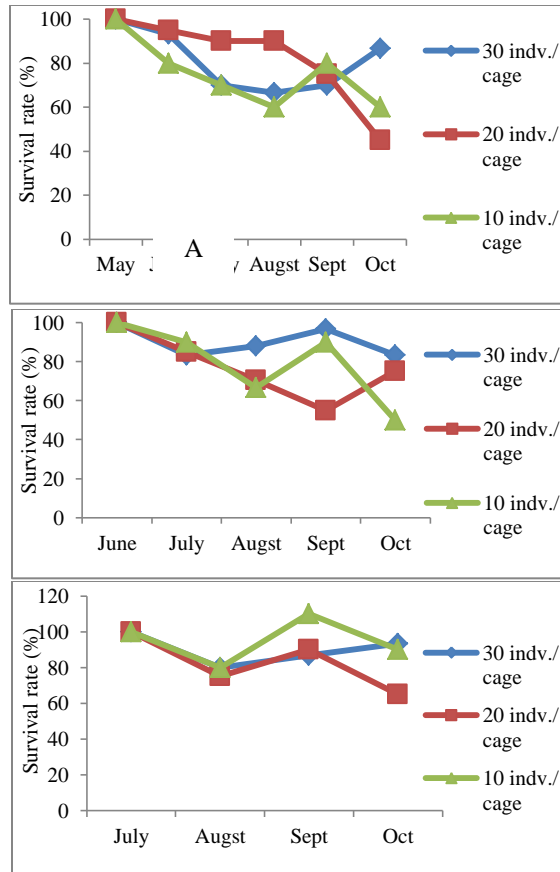

Figure 3. Survival rate of sea cucumber *Holothuria atra* reared at different stocking times and densities (A = stocking at month 0 from the start of installation of bottom cages, B = month 1 after cages is installed, and C = month 2 after cages installed)

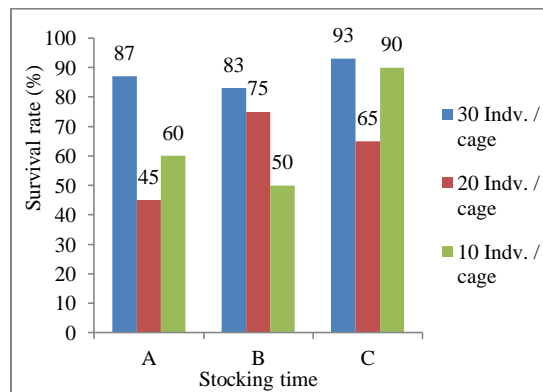

Figure 4. Survival rate of sea cucumber *Holothuria atra* reared at different stocking times and densities in the end of experiments (A = stocking at month 0 from the start of installation of bottom cages, B = month 1 after cages is installed, and C = month 2 after cages installed)

During reared in the cage with different stocking density and stocking time, the sea cucumbers dis asexual reproduction or fission (Table 1). Most of these phenomena were not

directly observed, but individual results of fission can be distinguished from normal individuals (Figures 5).

Stoking time	Stocking density		
	30	20	10
1	8	11	2
2	8	9	8
3	8	10	5
Total fission	24	30	15

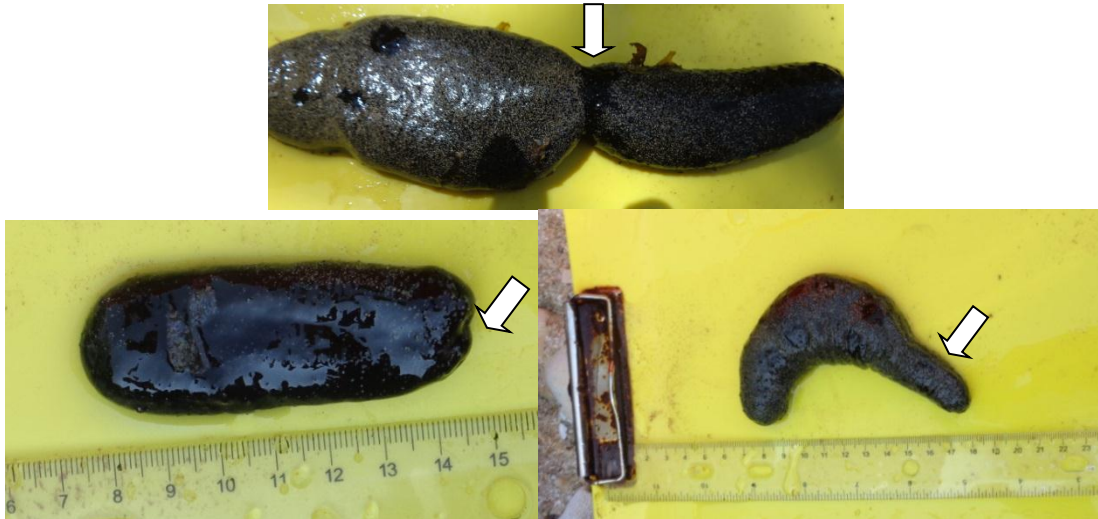

Figure 5. Sea cucumbers that are undergoing fission (A), have just undergone fission and the wound of the cleavage has been closed (B) and the regenerated (C) (→ arrow mark k is position of fission/fission plane and regeneration)

Sea cucumbers naturally have great potential to regenerate after the process of evisceration (expell of their internal organs). Evisceration occurs due to physiological changes or in response to various external factors. During evisceration, sea cucumbers secrete a large portion of their internal organs and within a certain period of time they will grow back and live normally [13]. Regeneration also occurs after the process of asexual reproduction by fission. This process will produce new individuals with regeneration in the posterior or anterior part.

The process of fission naturally occurs as in Figure 5, there appears to be a narrowing of the part of the body that will divide (Figure 5A). After splitting (fission), a new individual will close the wound in the division section (fission plane) (Figure 5B) and the initial regeneration appears a bulge in the fission plane and then regeneration) of the body part is shown in Figure 5C. This fission process can provide a high survival rate data but it will produce smaller sea cucumber individuals.

In this study in general the densely populated population experienced more fission than the non-dense one, but the stocking time did not significantly affect the number of fission individuals (Table 1). According to [23] and [24] fission is a phenomenon that is highly dependent on population density even though [25] showed that fission in dense and low populations was not significantly different. In nature fission is considered to play a role in maintaining populations in some types of holothurian to compensate for mortality and migration [26][27].

Microphytobentic biomasses which are food sources of sea cucumber *H. atra* are measured in the form of chlorophyll-a, chlorophyll-b, chlorophyll-c, phaeophytin and total carotene in sediments, the results of which are shown in Figures 6 and 7.

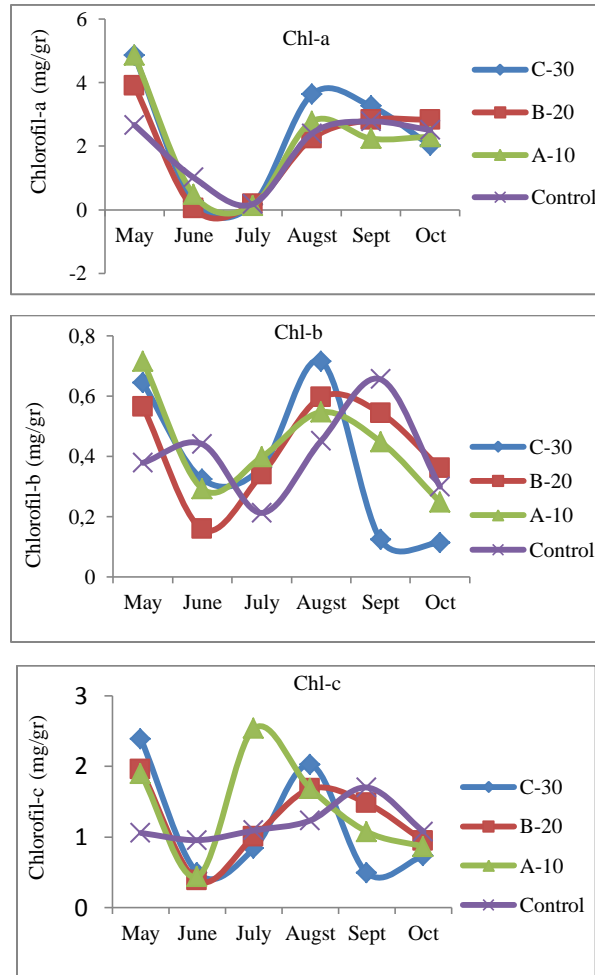

Figure 6. Concentration of chlorophyll-a, chlorophyll-b, and chlorophyll-c, in sediments of sea cucumber *H. atra* cages which are reared at different densities

The trend in the concentration of chlorophyll a, b, c, phaeophytin and total carotene is almost the same in all cages, which is high in the first month, decreases in the second and third months of sea cucumber rearing and increases in the following month and decreases again in the last month of the study (Figure 6 and 7). Microphytobenthos or benthic microalgae describe as groups of photoautotrophic microorganisms that inhabit the surface layers of sediments of shallow aquatic ecosystems such as diatoms, cyanobacteria and other chlorophytes [28]. In shallow coastal waters microphytobenthos plays an important role in the metabolic system. They significantly contribute to primary production [29]. They are important food sources for meiofauna such as sea cucumbers [30]. This prediction will cause fluctuations in concentration as stated by [31]. Chlorophyll c is a very sensitive marker of algae containing chlorophyll c biomass [32] and the ratio of total chlorophyll c and b to chlorophyll a can be a good indicator of the amount of diatomic and green algal biomass.

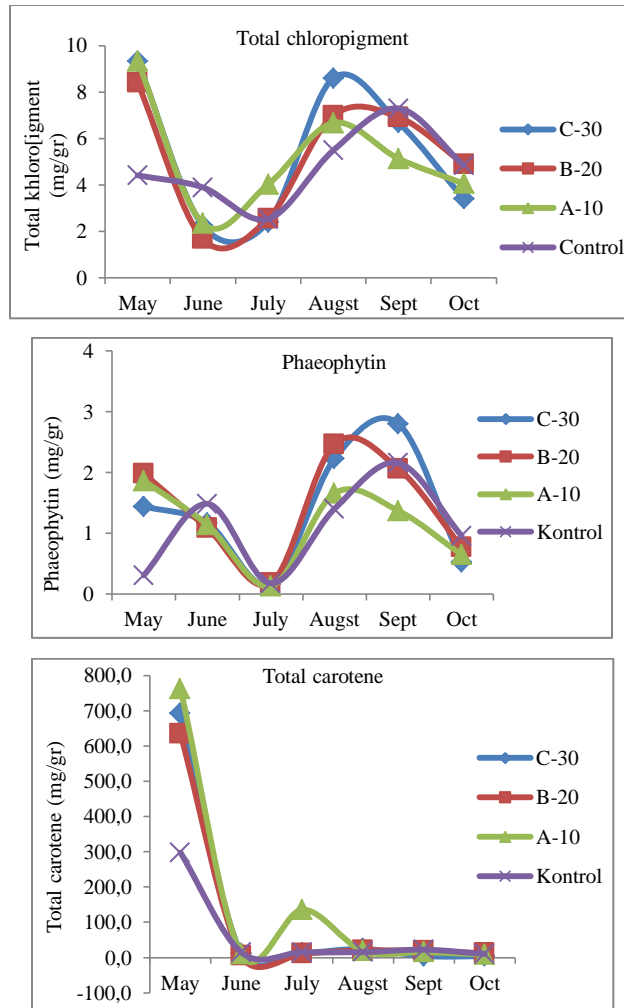

Figure 7. Concentration of total chloropigment, phaeophytin and total carotene in sediments of sea cucumber *H. atra* cages which are reared at different densities.

According to [33], bottom sediment characteristics are one of the important components that influence sea cucumber habitat preferences and hence studies of the characteristics of sea cucumber sediment are very important to do. Rocky sediments should be avoided because sea cucumbers live in mud or sand and remain in the organic material in the same place. *H. atra* is a deposit feeder that swallows sediment with organic matter [34], and their intestinal contents are dominated by decaying macroalgae and seaweed, shell fragments from molluscs, crustaceans and barnacles, echinoderm ossicles, many pelagic and benthic foraminifers and diatom [35].

Some studies also show that sea cucumbers swallow marine animal feces [36], even their own feces. [37] state that in shallow water (<10 m) *H. atra* prefers seagrass habitats with sediments with 15-25% gravel and coarse sand (0.7–1.2 mm) but not mud. [38].

also found that *H. atra* was mainly in sand-dominated habitats. Preference for specific habitat characteristics seems to be related to their feeding and protection [38][39]

Water quality parameters (temperature, salinity, pH and dissolved oxygen) during rearing of *H. atra* are measured and presented in Figure 8. Water temperature is considered to be one of the most important parameters affecting the level of growth and development of sea cucumbers and their distribution in the sea. Temperatures in seawaters tend to be stable

throughout the study period, which is 28-30°C (Figure 8). The temperature between cage were not significantly different because of the location of cage were closed each others. [39] reported optimum temperature for *H. atra* range 27-30 °C The process of aestivation (adaptation to high temperatures) has not been widely discussed in *H. atra*, but usually during the day *H. atra* will cover the body with sand which is thought to be a response to high temperatures.

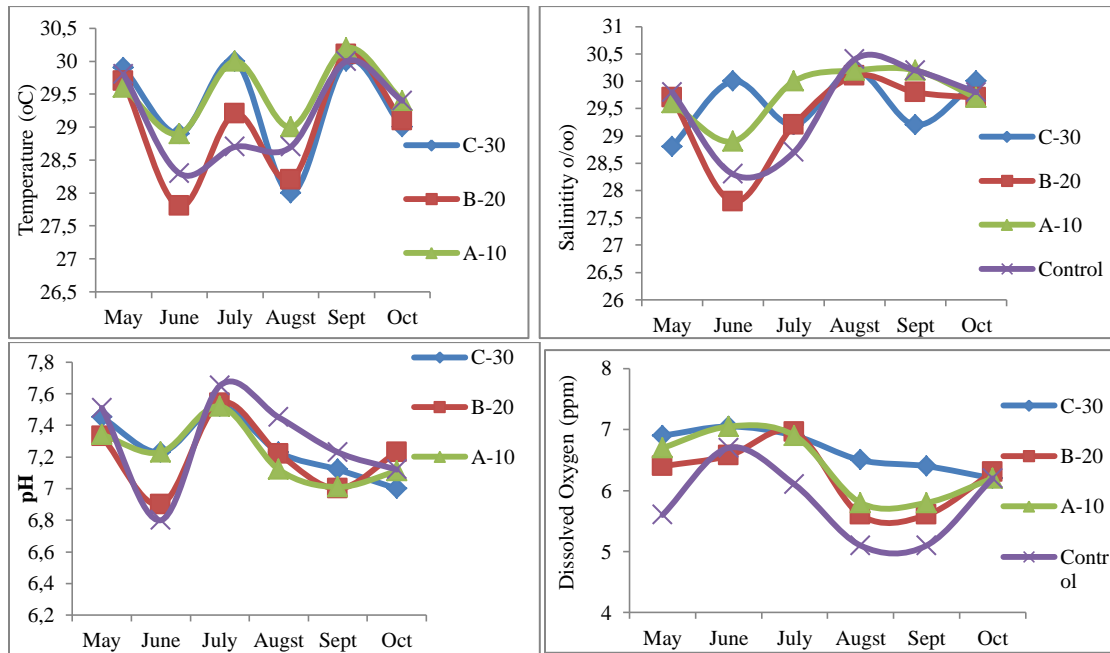

Figure 8. Average temperature, salinity, pH and dissolved oxygen of sea water in *H. atra* rearing cage with different stocking density

Sea cucumbers are stenohaline invertebrates that cannot tolerate a wide range of salinity. Therefore river mouths, estuaries and other bays where salinity falls below 10 ppt during the monsoon season should be avoided. Although there is a small river that goes into Teluk Awur waters, it does not affect the salinity around the cages which is 500 meters far from the estuary. Salinity in the Teluk Awur waters is presented in Figure 8, which ranges from 27.5-30.5 ‰ which is still suitable for the life of sea cucumbers.

In addition to temperature and salinity, water pH will affect the life of sea cucumber *H. atra*. pH fluctuations occur seasonally where the dry season is characterized by high water temperatures and low water movements/currents that produce low pH values between 7.3-7.5, while pH increases to 8.4- 8.6 during the rainy season because the entry of high water influx [40]. [41] say that in general, vertebrates have the ability to regulate osmotic pressure and very good acid-base conditions and therefore are better able to cope with changes in pH compared to invertebrates that have lower regulatory capacity, but information about the effect of pH on sea cucumber was very little. According to [23], temperatures of 28–32°C, salinity 35 ppt and pH 7.8 are optimum conditions for maintenance of *H. spinifera* larvae. In sea cucumbers, *I. badiotus* which is exposed to pH up to 7.70 results in increasing metabolic rate and antioxidant enzyme activity. Epidermal layer in sea cucumber *I. bionotus* is known to be a very important defense barrier that is activated by changes of environment, especially by the pH of sea water. During maintenance of *H. atra*, pH in cages ranges from 6.8-7.6

Sea cucumber is a deposit feeder that respire with all the tentacles, skin and respiration trees by consuming lots of water and absorbing dissolved oxygen inside. In his research [42] found that the limit of hypoxia for *H. leucospilota* was 3 mg O₂ /L wherein the sea cucumber released its cuverian tube to lower its energy needs in its aesthetic process. Furthermore, it is also said that the normal conditions of dissolved oxygen > 6 mg/L provide a 100% survival rate. At maintenance of *A. japonicus*, Liao dissolved oxygen is maintained at > 5 mg/L [43]. Normal oxygen content in coastal waters ranges from 5-8 mg/L [44]. During the rearing period the dissolved oxygen content in the cages ranged from 6-7 mg/L (Figure 8) there were no signs of *H. atra* evisceration due to hypoxia.

CONCLUSION

Black sea cucumbers (*Holothurian atra*) reared in the bottom cage in Teluk Awur waters of Jepara with low stocking densities (10 individuals / cage) produce higher growth and survival rates. Stocking time in the second month after the cages were installed also results in higher growth. Chlorophyll a, b, c, phaeophytin and carotene levels fluctuate according to the time of sea cucumber rearing caused by their feeding and bioturbation activities.

REFERENCES

- [1] Anderson, S.C., Mills-Flemming, J., Watson, R. and Lotze, H.K. 2011, Serial exploitation of global sea cucumber fisheries. *Fish and Fisheries*, **12**: 317–339.
- [2] Hartati, R., P. Purwati dan Widianingsih, 2015, *Field Guide Timun Laut Di Kepulauan Karimunjawa*. Pohon Cahaya. Yogyakarta, 37 halaman.
- [3] Conand, C., 2004, Present status of world sea cucumber resources and utilization: an international overview. Workshop on Advances in Sea Cucumber Aquaculture Management, Dalian (China), 14–18 Oct 2003
- [4] Bell, Johann D., Steven W. Purcell, Warwick J. Nash. 2008a. Restoring small-scale fisheries for tropical sea cucumbers. *Ocean & Coastal Management* **51**: 589–593.
- [5] Bell, J. D., Kenneth M. Leber, H. Lee Blankenship, Neil R. Loneragan, and Reiji Masuda. 2008b. A New Era for Restocking, Stock Enhancement and Sea Ranching of Coastal Fisheries Resources Reviews in fisheries science vol. 16 nos. 1–3 2008
- [6] Purcell, S.W., Hair, C.A., Mills, D.J., 2012a. Sea cucumber culture farming and sea ranching in the tropics: progress problems and opportunities. *Aquaculture* **368**: 68–81. <http://dx.doi.org/10.1016/j.aquaculture.2012.08.053>.
- [7] Purcell, S.W., Mercier, A., Conand, C., Hamel, J.F., Toral- Granda, M.V., Lovatelli, A., Uthicke, S., 2012b. Sea cucumber fisheries: global analysis of stocks management measures and drivers of overfishing. *Fish Fish*. **14**: 34–59. <http://dx.doi.org/10.1111/j.1467-2979.2011.00443.x>.
- [8] Hartati, R., Widianingsih, D. Pringgenies. 2005. Teknologi penyediaan pakan bagi teripang putih (*Holothuria scabra*). Laporan Penelitian Hibah Bersaing XII Tahun ke 2 Lemlit UNDIP, 48 hal.
- [9] Xie, X., W. Zhao, M. Yang. 2013.

Combined influence of water temperature, salinity and body size on energy budget in the sea cucumber *Apostichopus japonicus* Selenka. *Fish Sci.*, **79**: 639-646.

- [10] Zonghe, Y., Z. Y. Zhou, H. Yang, Y. Mae, C. Hu. 2014. Survival, growth, food availability and assimilation efficiency of the sea cucumber *Apostichopus japonicus* bottom-cultured under a fish farm in southern China. *Aquaculture*, **426-427**: 238-248
- [11] Hartati, R., Widianingsih, Delianis Pringgenies. 2009b. *Pembenihan dan pembesaran Teripang Pasir (Echinodermata: Holothuroidea)*. Badan penerbit Universitas Diponegoro. Semarang. 128 hal.
- [12] Purcell SW, and NS Agudo, 2013. Optimisation of Mesh Enclosures for Nursery Rearing of Juvenile Sea Cucumbers. *PLoS ONE* **8(5)**: e64103. <https://doi.org/10.1371/journal.pone.0064103>
- [13] Hartati, R., Widianingsih dan Hadi Endrawati. 2016. The Growth of Sea cucumber *Stichopus herrmanni* After Transverse Induced Fission in Two and Three Fission Plane. *Ilmu Kelautan IJMS Indonesian Journal of Marine Science* 21(2) : 93-100
- [14] Chuanxin, Q., D. Shuanglin, T. Fuyi, T. Xiangli, W. Fang, D. Yunwei, G. Qinfeng. 2009. Optimization of Stocking Density for the Sea Cucumber, *Apostichopus japonicus* Selenka, Under Feed-Supplement and Non-Fed-Supplement Regimes in Pond Culture. *J. Ocean Univ. China (Oceanic and Coastal Sea Research)*. 8 (3): 296-302 DOI 10.1007/ s11802-009-0296-1
- [15] Seeruttun, R., C. Appadoo, A. Laxminarayana & B. Codabaccus. 2008. A Study on the Factors Influencing the Growth and Survival of Juvenile Sea Cucumber, *Holothuria atra*, under Laboratory Conditions. *University of Mauritius Research Journal* **14** :1-15
- [16] Domínguez-Godino, J.A. and González-Wangüemert, M. 2018. Does space matter? Optimizing stocking density of *Holothuria arguinensis* and *Holothuria mammata*. *Aquaculture Research* DOI: 10.1111/ARE.13773
- [17] [Pei, S.](#), [S. Dong](#), [F. Wang](#), [X. Tian](#), [Q. Gao](#) 2012. Effects of density on variation in individual growth and differentiation in endocrine response of Japanese sea cucumber (*Apostichopus japonicus* Selenka). *Aquaculture* **356-357**: 398-403 DOI [10.1016/j.aquaculture.2012.04.032](https://doi.org/10.1016/j.aquaculture.2012.04.032)
- [18] Lavitra, T., R. Rasolofonirina, I. Eeckhaut. 2010a. The Effect of Sediment Quality and Stocking Density on Survival and Growth of the Sea Cucumber *Holothuria scabra* Reared in Nursery Ponds and Sea Pens. *Western Indian Ocean J. Mar. Sci.* 9(2): 153-164.
- [19] Conand C. 2006a Sea cucumber biology: Taxonomy, distribution, biology, conservation status. In: Proceedings of the CITES workshop on the conservation of sea cucumbers in the families Holothuridae and Stichopodidae. Bruckner AW (eds) NOAA Technical Memorandum NMFSOPR 34, Silver Spring. pp 30-46

- [20] Taddei, D. 2006. Transfert de matière et d'énergie dans les sédiments d'un complexe récifal anthropisé (Ile de la Réunion, Océan Indien). [Thèse] Université de la Réunion, U.F.R. Sciences et Technologies. 229 pp.
- [21] Lavitra T, Fohy N, Gestin P, Rasolofonirina R, Eeckhaut I. 2010b. Effect of water temperature on the survival and growth of endobenthic *Holothuria scabra* (Echinodermata: Holothuroidea) juveniles reared in outdoor ponds. *SPC, Bêche-de-mer Bulletin* **30**: 25-28
- [22] Pitt R, and Duy NDQ. 2004. Breeding and rearing of the sea cucumber *Holothuria scabra* in Viet Nam. In: Advances in sea cucumber aquaculture and management. Lovatelli A, Conand C, Purcell S, Uthicke S, Hamel JF, Mercier A. (eds) Fisheries Technical Paper No 463, FAO, Rome. pp 333-346
- [23] Asha P. S. and K. Diwakar. 2015. Field observation of asexual reproduction by fission in sea cucumber *Holothuria atra*. *Mar. Fish. Infor. Serv., T & E Ser.*, 223 & 224: 29-30
- [24] Hartati, R. M. Zainuri, A. Ambariyanto, F.P. Ayodya, W. Widianingsih, M. Mustagfirin. 2018a. Initial assesment of *Holothuria atra* population in Panjang Islands. The 1st International Conference on Fisheries and Marine Science. Universitas Airlangga Surabaya, 6th October 2018.
- [25] Lee J., M. Byrne, S. Uthicke 2008b The influence of population density on fission and growth of *Holothuria atra* in natural mesocosms *Journal of Experimental Marine Biology and Ecology* **365** (2008): 126–135
- [26] Chao, S.M., Chen, C.P., Alexander, P.S., 1994. Reproduction and growth of *Holothuria atra* (Echinodermata: Holothuroidea) at two contrasting sites in southern Taiwan. *Mar. Biol.* **119**, 565–570.
- [27] Uthicke, S., 2001a. Influence of asexual reproduction on the structure and the dynamics of *Holothuria* (*Halodeima*) *atra* and *Stichopus chloronotus* populations of the Great Barrier Reef. *Mar. Freshw. Res.* **52**: 205–215
- [28] Sullivan MJ, and CA Currin. 2000 Community structure and functional dynamics of benthic microalgae in salt marshes. In: Concepts and controversies in tidal marsh ecology. Weinstein MP, Kreeger DA (eds) Kluwer Academic Publishers, Dordrecht, p 81–106
- [29] Hardiso, A.K., E.A. Canuel, I.C. Anderson, C.R. Tobias, B. Veuger, and M.N. Waters. 2013. Microphytobenthos and benthic macroalgae determine sediment organic matter composition in shallow photic sediments. *Biogeosciences*, **10**: 5571–5588. www.biogeosciences.net/10/5571/2013/. doi:10.5194/bg-10-5571-2013
- [30] Blanchard, G. F. 1991. Measurements of meiofauna grazing rates on microphytobenthos: is primary production a limiting factor? *J. Expl. Mar. Biol. Ecol.*, **147**:37-46.
- [31] Hartati, R., A. Ambariyanto, M. Zainuri, W. Widianingsih, E. Supriyo, A. Trianto. 2018b. The concentration of chlorophyll-c in the bottom sediment of sea cucumber rearing cage. The 4nd International Conference on Tropical and Coastal Region Eco Development 2018. Semarang, 30-31 October 2018.

- [32] Kowalewska, G., A. Witkowski., B. Toma. 1996. Chlorophylls *c* in bottom sediments as markers of diatom biomass in the southern Baltic Sea. *OCEANOLOGIA*, **38(2)**: 227–249.
- [33] Slater, M. J. and Jeffs, A. G. 2010. Do benthic sediment characteristics explain the distribution of juveniles of the deposit-feeding sea cucumber *Australostichopus mollis*? *J. Sea Res.*, **64**: 241–249
- [34] Michio, K., Kengo, K., Yasunori, K., Hitoshi, M., Takayuki, Y., Hideaki, Y., Hiroshi, S., 2003. Effects of deposit feeder *Stichopus japonicus* on algal bloom and organic matter contents of bottom sediments of the enclosed sea. *Mar. Pollut. Bull.* **47**: 118–125.
- [35] Zhang, B.L., Sun, D.L., Wu, Y.Q., 1995. Preliminary analysis on the feeding habit of *Apostichopus japonicus* in the rocky coast waters off Lingshan Island. *Mar. Sci.* 3: 11–13 (in Chinese, with English abstract).
- [36] Zhou, Y., Yang, H.S., Liu, S.L., Yuan, X.T., Mao, Y.Z., Liu, Y., Xu, X.L., Zhang, F.S., 2006. Feeding and growth on bivalve biodeposits by the deposit feeder *Stichopus japonicus* Selenka (Echinodermata: Holothuroidea) co-cultured in lantern nets. *Aquaculture* **256**:510–520
- [37] Dissanayake, DCT., and G. Stefansson. 2012. [Habitat preference of sea cucumbers: *Holothuria atra* and *Holothuria edulis* in the coastal waters of Sri Lanka](#) . *J. of the Mar. Biol. Ass. of the UK*. 92(3): 581-590
- [38] Hartati, R., A. Trianto, and Widianingsih , 2017a. Habitat characteristic of two selected locations for sea cucumber ranching purposes. 2017 IOP Conf. Ser.: Earth Environ. Sci. 55 012041 (<http://iopscience.iop.org/1755-1315/55/1/012041>)
- [39] Hartati, R., Widianingsih, A. Trianto, M. Zainuri, Ambariyanto. 2017b. The abundance of prospective natural food for sea cucumber *Holothuria atra* at Karimunjawa Island waters, Jepara, Indonesia. *BIODIVERSITAS* **18(3)**: 947-953
- [39] Ramofafia, C., Gervis, M., Bell, J., 1995. Spawning and early larval rearing of *Holothuria atra*. *SPC Beche-de-mer Inf. Bull.* 7: 2– 7.
- [40] Gullian, K.M, and T.M. Preciat. 2017. Effect of pH on temperature controlled degradation of reactive oxygen species, heat shock protein expression, and mucosal immunity in the sea cucumber *Isostichopus badionotus*. PLoS ONE 12(4): e0175812. <https://doi.org/10.1371/journal.pone.0175812>
- [41] Wittmann, AC, and HO. Portner. 2013. Sensitivities of extant animal taxa to ocean acidification. *Nat Clim Change*. **3**: 995±1001
- [42] Zamani, N.P., K. Assidqi and H. Madduppa. 2018. Study of the Tolerance of Black Sea Cucumber *Holothuria leucospilota* to Hypoxia Stress. *Pertanika J. Trop. Agric. Sc.* **41(3)**: 1511 - 1521
- [43] Renbo, W. and C. Yuan. 2004. Breeding and culture of the sea cucumber, *Apostichopus japonicus*, Liao . in A. Lovatelli, C. Conand, S. Purcell, S. Uthicke, J-F. Hamel, A. Mercier

(Eds.) Advances in sea cucumber aquaculture and management FAO Fisheries Technical Paper 463

- [44] Diaz, R.J. & Rosenberg, R. (1995) Marine benthic hypoxia: A review of its ecological effects and the behavioural responses of benthic macrofauna. *Oceanogr Mar Biol* **33**: 245-303

Appendix 2. Article presented in The 4nd International Conference on Tropical and Coastal Region Eco Development 2018. Semarang, 30-31 October 2018.

The concentration of chlorophyll-c in the bottom sediment of sea cucumber rearing cage

Retno Hartati*^{1,2}, Ambariyanto Ambariyanto¹, Muhammad Zainuri³,
Widianingsih Widianingsih¹, Edy Supriyo³, Agus Trianto¹

¹Marine Science Departement, Faculty of Fisheries and Marine Science, Diponegoro University Jl. Prof. Soedharto, SH, Tembalang, Semarang telephone & fax : 0247474698;

²Regional Study Center for Tropical Biology Research (SEAMEO BIOTROP)

³Oceanography Departement, Faculty of Fisheries and Marine Science, Diponegoro University

³Chemical Engineering Department, School of Vocation, Diponegoro University

retnohartati.undip@yahoo.com

Abstract. The total chlorophyll-c has been proved as indicator of the occurrence of diatom and green algal biomass in sediments. Those chlorophyll-c-containing algae acts as food of sea cucumber reared in the cage. The present study was aimed to examine the total chlorophyll-c in the bottom sediment of sea cucumber *Holothuria atra* rearing cage with high stocking density (40 ind.4m⁻²). The sample of sediments were collected from 0-3 cm surface layer of bottom sediment during Mei-July. The chlorophyll-c were analysed spectrophotometrically. Pigments are extracted from 10 grams of wet sediment using 20 ml of 90% acetone into glass tubes with a screw cap. After 24 hours of darkness at 4°C, extracts are centrifused for 2500 rpm for 5 min, filtrate then analyzed for Chlorophyll-c. A Perkin-Elmer Lambda 3BUV/VIS spectrophotometer with a 1 nm spectral bandwidth and optically matched 4 cm micro-cuvettes are used in the present work. The result showed that the chlorophyll-c concentration in the bottom cage sediment fluctuated, decreased due to activity of sea cucumber feeding on microphytobenthos and increased due to their bioturbation activity.

1. Introduction

Microphytobenthos or benthic microalgae describes the group of photoautotrophic microorganisms inhabiting surficial sediments of shallow aquatic ecosystems such as diatoms, cyanobacteria and other chlorophytes[1]. Within shallow coastal waters microphytobenthos play an important role in system metabolism. They are significantly contribute to primary production[2]. Because much of the sediment surface resides within the euphotic zone, benthic autotrophs often are the dominant primary producers. They are able to photosynthesize at low light levels[3], taking advantage of the usually higher nutrient concentrations in the sediment[4] and therefore microphytobenthos fundamentally are able to alter sediment organic matter (SOM) quality and quantity[5]. Since biomass may accumulate at this layer, its contribution to the overall system productivity is often significantly higher than the integrated adjacent water-column[6][7]. It is not surprising that they are an important food source for meiofauna such as sea cucumber[8] and many more estuarine consumers. Understanding the relationship between the food availability and the organism cultured is important as a key success of sea cucumber rearing.

The total chlorophylls *c* in sediments is a very sensitive indicator of the occurrence of chlorophyll *c*-containing algae in the over-lying water column[5]. Chlorophylls *c* were found in

unicellular chromophyte algae *i.e.* diatoms, dinoflagellates, prymnesiophytes and chrysophytes. Therefore the present work was aimed to measure the chlorophyll-c in the bottom sediment of sea cucumber cage.

2. Materials and methods

The samples of sediment were collected from 0-3 cm surface layer of bottom sediment of sea cucumber *H. atra* rearing cage during Mei-July. The chlorophyll-c were analysed spectrophotometrically. Pigments are extracted from 10 grams of wet sediment using 20 ml of 90% acetone into glass tubes with a screw cap. After 24 hours of darkness at 4°C, extracts are centrifused for 2500 rpm for 5 min, filtrate then analyzed for Chlorophyll-c by spectrophotometer following procedures of [9] modified by [10] and [11]. A Perkin-Elmer Lambda 3BUV/VIS spectrophotometer with a 1 nm spectral bandwidth and optically matched 4 cm micro-cuvettes are used in the present work. The chlorophyll-c was calculated using following formula.

$$\text{Chl-c (mg.g}^{-1}\text{)} = \frac{((55 \cdot A_{630}) - (4,64 \cdot A_{665}) - (16,3 \cdot A_{645})) \times 10000 \times 0,002}{L \times p}$$

3. Results

Microphytobenthos inhabit the top few centimeters of the substrate layers (mud or sand) of marine sediment where has sufficient light for photosynthesis[7]. Benthic microalgae have an important role as a food source for higher trophic levels in shallow water as well as estuarine food webs. [12]also proved that a host of benthic consumers including omnivores, suspension feeders and deposit feeders (such as sea cucumber) mostly rely on benthic microalgae for food.

The contents of total chlorophylls *c* in bottom sediments of sea cucumber rearing cage are presented in Fig. 1. Chlorophylls *c* are very sensitive markers of chlorophyll *c* containing algae[5]. Moreover, the concentrations of these pigments in sediments can be treated as indicators of the diatoms living in sediments and the overlying waters regarding disturbances caused by local currents and the conditions of deposition. They are rather an indicator of biomass than of the number of cells or species. The ratio of total chlorophylls *c* and *b* to chlorophyll *a* could be a valuable indicator of diatom and green algae biomass. The diatom in a typical of shallow-water assemblages were represented by both attached (epipsammic) and motile (epipellic) species in which the former being strongly predominant. In their work [5] showed that the most abundant of them were *Achnanthes delicatula*, *Opephora olsenii*, *Opephora* sp., *Fragilaria sopotensis*, *Navicula cryptocephala*, *N. germanopolonica* and *N. paul-schulzii*. While in the deeper water (more than 5 meter), these sediments were predominantly inhabited by planktonic diatom taxa which settled onto the bottom from the water column. The sediments contained whole diatom cells, a certain amount of detritus and resting spores. the diatom flora was mainly composed of resting spores of *Chaetoceros* spp. or dominated by *Thalassiosira* cf. *decipiens* and *Cyclotella choctawhatcheeana*.

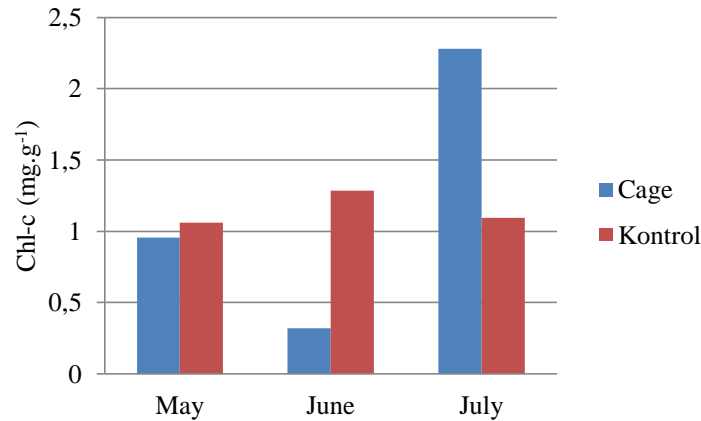

Figure 1. The concentration of Chlorophyll-c in the bottom sediment of *H. atra* rearing cage

From Fig.1. could be seen that in the beginning, the chlorophyll-c in the sedimen of the cage and controll (without cage) were almost the same. In June, there was decreasing of chlorophyll-c concentration but during July there was significant increments of cell densities at the sediment. During this period because in the cage, the physical characteristic of the water may not give effect on the microphytobenthic community. Although actual current speeds were not measured, this event might have helped alleviate physical stress in the cage, and microphytobenthic could stay and grow well in the bottom layer of the cage and increase the chlorophyll-c on July. In the contrary, the chlorophyll-c were decreased in control site. There are many potential ecological consequences due to decreasing microphytobenthic production. One of them For example, biogeochemical processes such as nitrification and denitrification are affected by diel variations in oxygen related to microphytobenthic metabolism as well as competition with microphytobenthos for dissolved N [13][14].

As happen in nature [15] during periods of high grazing pressure (in this case during June), microphytobenthic community production was more than sufficient to supply food resources for meiofaunal consumers, i.e. sea cucumber. The similar result showed by [16] that in the intensive *Holothuria scabra* farming the concentration of photosynthetic microorganisms fell by up to 22% within sea farm pens and showed the grazing by sea cucumber. [17] also recorded the highest growth rate of *Australostichopus mollis* when microphytobenthic activity was the highest. Sea cucumber mostly digest bacteria, cyanobacteria, decaying plant (e.g., seagrass and algae) matter, some diatoms, foraminiferans, fungi, and other organic matter that constitute detritus [18][19][20][12].

It is therefore not surprising that the concentrations of bacteria and photosynthetic microorganisms (microphytobenthic) decreased in the pens. Microphytobenthos biomass, like most microbial communities, is regulated by both top-down and bottom-up controls[21][22]. Grazers can potentially limit their standing stock via high consumption rates[23][24][25] as well as high grazing pressure by deposit-feeding macrofauna may also reduce microphytobenthos abundance [26], while nutrients and light may regulate their biomass and productivity [27]. In addition, grazers may indirectly stimulate microphytobenthos production by enhancing nutrient availability while simultaneously ‘thinning’ the microalgal overstory and allowing deeper penetration of light into the sediments[28][29]. *H. atra*, as many other aspidochirote sea cucumbers, feed on large quantities of sediments and convert organic detritus into animal tissue and nitrogenous wastes, which can be taken up by algae[30][31]. Higher grazing rates will also likely result in a redistribution of nutrients (as waste products from sea cucumber), enhanced rates of nutrient regeneration, and subsequent growth [32]. Microphytobenthos as measured by chlorophyll-c in the upper few millimeters of sediment seems to be limited primarily by the

availability of resources (light, nutrients, etc.) [7]. [22] examined the interactive effects of consumers and resources on ecosystem structure and function, and showed that when consumers are present, peak diversity occurs at higher levels of nutrient supply.

Bioturbation and sediment reworking by meiofaunal activities, such as sea cucumber [33], may also increase porosity and solute transport rates, facilitating porewater exchange and nutrient supply to microphytobenthos[34]. Thus, diversity and primary productivity depend on the relative rates of nutrient supply and consumer pressure in many marine food webs. This results are inline with the general community structuring principles[22] and showed strong relationship between microalgae and meiofauna in the upper few millimeters of sediments. The trophic relationships are complex, with linked feedback mechanisms that operate over small spatio-temporal scales[35]. The coupling of measurements of rate and biomass responses for both producers and grazers has provided some useful insights into possible mechanisms underlying sea cucumber-microalgal trophodynamics in bottom cage. Aside from the light, the texture and relief of the sediment surface of bottom cage and its organic content also determine the vertical distribution of microphytobenthos communities[36][37][38]. As the top layers of the sediment represent a zone with such remarkably strong physicochemical gradients, most benthic microalgae show adaptive diurnal and tidal rhythms of vertical migration, moving in response to light, tide cycles, desiccation, predation and resuspension[39][40][41]. Microphytobenthos may be able to migrate vertically from 10 to 27 mm.h⁻¹[42]. Furthermore, in microscale horizontal gradients, nutrient, irradiance, water content and salinity may affect the vertical gradients, and their combination affect the growth of microphytobenthos communities[43]. A study on sea cucumber species of *Australostichopus mollis* revealed that nutrient release from holothuroids can increase benthic productivity[12]. Furthermore they said that losses of microalgae from consumption by sea cucumbers outweighed the increased productivity of microalgae from nutrients they excreted.

4. Conclusions

The concentration of chlorophyll-c as represent of microphytobenthic biomass in the sediment of bottom cage were more fluctuated during period of sea cucumber rearing that might be due to their feeding and their bioturbation activity compare to controll samples.

References

- [1] Sulliva MJ, Currin CA 2000 Community structure and functional dynamics of benthic microalgae in salt marshes. In: Weinstein MP, Kreeger DA (eds) Concepts and controversies in tidal marsh ecology. Kluwer Academic Publishers Dordrecht 81–106
- [2] Hardiso AK, EA Canuel, IC Anderso, CR Tobias, B Veuger, MN Waters 2013 Microphytobenthos and benthic macroalgae determine sediment organic matter composition in shallow photic sediments. Biogeosciences, **10** 5571–5588 www.biogeosciences.net/10/5571/2013/. doi:10.5194/bg-10-5571-2013.
- [3] Blanchard GF, PA Montagna 1992. Photosynthetic response of natural assemblages of marine benthic microalgae to short- and long-term variations of incident irradiance in Baffin Bay, Texas J Phycol. **28** 7-14.
- [4] Queiroz RL, FP Brandini, FM Pellizzari 2004 Dynamics of microalgal communities in the water-column/sediment interface of the inner shelf off Parana State, Southern Brazil. Brazilian J. of Oceanography, **52** 3/4183-194.
- [5] Kowalewska GA, B Witkowski, Toma, 1996 Chlorophylls *c* in bottom sediments as markers of diatom biomass in the southern Baltic Sea OCEANOLOGIA **38**(2) 227–249.
- [6] Cahoon LB, J Cooke 1992. Benthic microalgal production in Onslow Bay, North Carolina, USA. Mar. Ecol. Prog. Ser., **84**185-196

- [7] MacIntyre HL, RJ Geider, DC Miller 1996. Microphytobenthos: The ecological role of the "Secret Garden" of unvegetated, shallow-water marine habitats. I. Distribution, abundance and primary production *Estuaries* **19** 186-201
- [8] Blanchard GF 1991 Measurements of meiofauna grazing rates on microphytobenthos: is primary production a limiting factor? *J. Expl. Mar. Biol. Ecol.* **147** 37-46
- [9] Lorenzen G 1967 Determination of chlorophyll and phaeopigments: Spectrophotometric equations *Limnol. Oceanogr.* **12** 343-346.
- [10] Wellburn AR 1994 The Spectral determination of chlorophyll a and b as well as Total carotenoid, using various solvents with spectrophotometers of different resolutions. *J. Plant Physiol* **144** 307-313.
- [11] Dere S, G Tohit, R Sivaci 1998 Spectrofotometric determination of chlorophyll-a, b and total carotenoid contents of some algae species using different solvents. *Botany* **22** 113-17
- [12] MacTavish T, J Stenton-Dozey, K Vopel, C Savage 2012 Deposit-feeding sea cucumbers enhance mineralization and nutrient cycling in organically-enriched coastal sediments. *PLoS ONE* **7**, e50031.
- [13] An S, SB Joye 2001 Enhancement of coupled nitrification-denitrification by benthic photosynthesis in shallow estuarine sediments *Limnol. Oceanogr.* **46** 62-74
- [14] Rysgaard S, PB Christensen, LP Nielsen 1995 Seasonal-Variation in Nitrification and Denitrification in Estuarine Sediment Colonized by Benthic Microalgae and Bioturbating Infauna, *Mar. Ecol.-Prog. Ser.* **126** 111-121
- [15] Pinckney JL, KR Carman, SE Lumsden, SN Hymel 2003. Microalgal-meiofaunal trophic relationships in muddy intertidal estuarine sediments. *Aquat Microb Ecol* **31** 99-108
- [16] Plotieau T, J Baele, R Vaucher, C Hasler, D Koudad, I Eeckhaut 2013. Analysis of the impact of *Holothuria scabra* intensive farming on sediment Cah. Biol. Mar. **54** 703-711
- [17] Slater MJ, AG Jeffs 2010 Do benthic sediment characteristics explain the distribution of juveniles of the deposit-feeding sea cucumber *Austrolostichopus mollis*? *Journal of Sea Research* **64** 241-249.
- [18] Yingst JY 1976 The utilization of organic matter in shallow marine sediments by an epibenthic deposit feeding holothurian *J Exp Mar Biol Ecol* **23** 55-69
- [19] Moriarty DJW 1982 Feeding of *Holothuria atra* and *Stichopus chloronotus* on bacteria, organic carbon and organic nitrogen in sediments of the Great Barrier Reef. *Australian J Mar Freshw Res* **33** 255-263.
- [20] Uthicke S 1999 Sediment bioturbation and impact of feeding activity of *Holothuria (Halodeima) atra* and *Stichopus chloronotus*, two sediment feeding holothurians, at Lizard Island, Great Barrier Reef. *Bull Mar Sci* **64**, 129-141.
- [21] Carpenter SR, J Kitchell, JR Hodgson 1985 Cascading trophic interactions and lake productivity *BioScience* **35** 634-639
- [22] Worm B, HK Lotze, H Hillebrand, U Sommer 2002 Consumer versus resource control of species diversity and ecosystem functioning *Nature* **417** 848-851
- [23] Connor MS, JM Teal, I Valiela 1982 The effect of feeding by mud snails, *Ilyanassa obsoleta* (Say), on the structure and metabolism of a laboratory benthic algal community. *J Exp Mar Biol Ecol* **65** 29-45
- [24] Montagna PA 1984 In situ measurement of meiobenthic grazing rates on sediment bacteria and edaphic diatoms. *Mar Ecol Prog Ser* **18** 119-130
- [25] Carman KR, JW Fleeger, SM Pomarico 1997 Response of a benthic food web to hydrocarbon contamination. *Limnol Oceanogr* **42** 561-571
- [26] Miller DC, RJ Geider, HL MacIntyre 1996 Microphytobenthos: the ecological role of the 'secret garden' of unvegetated, shallow-water marine habitats. II. Role in sediment stability and shallow-water food webs. *Estuaries* **19** 202-212

- [27] Barranguet C, J Kromkamp, J Peene 1998 Factors controlling primary production and photosynthetic characteristics of intertidal microphytobenthos. *Mar Ecol Prog Ser* **173** 117–126
- [28] Jørgensen BB, DJ Des Marais 1986 A simple fiber-optic microprobe for high resolution light measurements: application in marine sediment. *Limnol Oceanogr* **31** 1376–1383
- [29] Kuhl M, C Lassen, BB Jørgensen 1994 Light penetration and light intensity in sandy marine sediments measured with irradiance and scalar irradiance fiber-optic microprobes. *Mar Ecol Prog Ser* **105** 139–148
- [30] Uthicke S, DW Klumpp 1998. Microphytobenthos community production at a near-shore coral reef: seasonal variation and response to ammonium recycled by holothurian. *Marine Ecology Progress Series* **169**: 1-11.
- [31] Uthicke S. 2001. Interactions between sediment-feeders and microalgae on coral reefs: grazing losses versus production enhancement. *Marine Ecology Progress Series* **210** 125-138.
- [32] McCormick PV 1994 Evaluating the multiple mechanisms underlying herbivore-algal interactions in streams. *Hydrobiologia* **291** 47–59
- [33] Purcell SW, C Conand, S Uthicke, M. Byrne 2016. Ecological roles of exploited sea cucumbers. *Oceanography and Marine Biology: An Annual Review* **54** 367-386
- [34] Aller RC, JY Aller 1992 Meiofauna and solute transport in marine muds. *Limnol Oceanogr* **37** 1018–1033
- [35] Buffan-Dubau E, KR Carman KR 2000 Diel feeding behavior of meiofauna and their relationships with microalgal resources. *Limnol Oceanogr* **45** 381–395
- [36] Jørgensen BB, Revsbech NP, Cohen Y, 1983, Photosynthesis and structure of benthic microbial mats, Microelectrode and SEM studies of four cyanobacterial communities, *Limnology Oceanography* **28** 1075-1093
- [37] Wiltshire KH 1992 The influence of microphytobenthos on oxygen and nutrient fluxes between eulittoral sediments and associated water phases in the Elbe Estuary, *In Marine Eutrophication and Population Dynamics, Proc, 25th EMBS, G, Colombo, I, Ferrari, V, U, Ceccherelli, R, Rossi eds, Olsen and Olsen, Fredensborg, 63-70,*
- [38] Wiltshire KH, 1993, The influence of photosynthetic oxygen production by microphytobenthos on the oxygen and nutrient status of sediment water systems in the Elbe estuary, *Verhandlungen der Internationalen Vereinigung für Theoretische und Angewandte Limnologie* **25** 1141-1146
- [39] Admiraal W 1984 The ecology of estuarine sediment inhabiting diatoms, *Progress in Phycological Research* **3** 269-270
- [40] Pinckney J, RG Zingmark 1991 Effects of tidal stage and sun angles on intertidal benthic microalgal productivity, *Mar Ecol Prog Ser* **76** 81-89
- [41] Paterson DM, KH Wiltshire, A Miles, J Blackburn, I Davidson, MG Yates, S McGorty, JA Eastwood 1998 Microbiological mediation of spectral reflectance from intertidal phytoplankton and microphytobenthos due to increased sediment fluxes in the Venice Lagoon, Italy. *Estuarine, Coastal and Shelf Science* **54** 773 – 792.
- [42] Chatterjee A 2014 Role of benthic microalgae in a coastal zone : biomass, productivity and biodiversity. Other. Université de Bretagne occidentale - Brest, 2014. English. <NNT : 2014BRES0005>. <tel-01668574>
- [43] Wolff WJ 1979 Flora and vegetation of the Wadden Sea, Report 3, Final Report of the Section Marine Biology of the Wadden Sea, published by A,A, Balkema, Rotterdam, The Netherlands



Certificate

_____ This to certify that _____

REINO HARTATI

Has contributed as

PRESENTER

**in The 4th International Conference on Tropical
and Coastal Region Eco-Development (ICTCRED) 2018**

Semarang, 31st October 2018



Prof. Dr. Ir. Agus Sabjono, M.Sc.

Dean of Faculty of Fisheries and Marine Science



Prof. Ir. Tri Winarni Agustini, M.Sc., Ph.D.

Chair Person

Appendix 3. Curriculum vitae of Prinsiples and member of Team

Biodata Ketua Tim Peneliti

A. Identitas Diri

1	Nama Lengkap (dengan gelar)	Ir. Retno Hartati, MSc.
2	Jenis Kelamin	P
3	Jabatan Fungsional	Lektor Kepala
4	NIP/NIK/Identitas lainnya	19620711 198703 2 001
5	NIDN	0011066209
6	Tempat dan Tanggal Lahir	Semarang, 11 Juli 1962
7	E-mail	Retnohartati.undip@yahoo.com
9	Nomer Telepon/HP	0248314945/081325862512
10	Alamat Kantor	Jl. Prof. Soedharto, SH Kampus tembalang Semarang
11	Nomor Telepon/Faks	0247474698/0247474698
12	Lulusan yang telah dihasilkan	S1 = 30 orang; S2=...orang; S3=...orang
13	Mata Kuliah yang Diampu	1 Avertebrata Laut
		2 Fisiologi Biota laut
		3 Penangkaran dan Restocking Biota Laut
		4 Zoologi Laut

B. Riwayat Pendidikan

	S1	S2	S3
Nama perguruan Tinggi	IPB	Institute of Aquaculture, Stirling University, Scotland	
Bidang Ilmu	Budidaya Perairan	Aquaculture	
Tahun Masuk-Lulus	1981-1986	1990-1991	
Judul Skripsi/Thesis/Disertasi	Pengaruh Pemberian Makanan Dengan Sumber Protein Berbeda Terhadap Pertumbuhan Udang Galah <i>Macrobrachium rosenbergii</i> de Mann	The Effect of Feeding Attractants on Behaviour and Performance of Juvenile <i>Penaeus Monodon</i> Fab	
Nama Pembimbing/Promotor	Dr.Ir. Ing Mokoginta, MSi.	Dr. Matthew Briggs	

C. Pengalaman Penelitian Dalam 5 Tahun Terakhir

(Bukan Skripsi, Tesis, maupun Disertasi)

No.	Tahun	Judul Penelitian	Pendanaan	
			Sumber*	Jumlah (juta Rp.)
1	2009	Ultrastruktur Alimentary canal dan absorpsi pakan teripang (Echinodermata: Holothuroidea) Pada Berbagai Variasi Kondisi Ekologis.	DP4M (Dikti)	75

2	2009	Fission Reproduction Sebagai Teknik Perbanyakkan individu Dalam Konservasi Timun Laut (Holothuria : Echinodermata)	DP4M (Dikti)	90
3	2009-2011	Eksplorasi mikroalga laut yang berpotensi sebagai biofuel dalam upaya pencaharian energi alternatif yang terbarukan.	DP4M (Dikti)	285
4	2011	Kajian Reproduksi, Food dan Feeding Habit Ikan Manyung yang Tertangkap dari Perairan Semarang.	FPIK, UNDIP,	7,5
5	2012	Struktur Komunitas Padang Lamun di perairan Pulau Kumbang, Kepulauan Karimunjawa	FPIK, UNDIP.	15
6	2012-2013	Pengkajian Ekosistem Sumberdaya Ikan di Kawasan Konservasi Perairan Kepulauan Karimunjawa, Jawa Tengah	BPKSI	200
7	2013.	Mapping keanekaragaman Hayati Pesisir dan Laut di Area PLTU Tanjung Jati B, Jepara.	PLTU TJ B	150
8	2013	Kajian Pendugaan Stok Data Terbatas serta pemodelan Ekosistem Ikan Karang	WWF	165
9	2015	Kajian Fenotip dan Genotip Teripang Famili Stichopodidae dan Famili Holothuriidae Dari Kep. Karimunjawa, Jepara	DP4M (Dikti)	60
10	2015	Teknologi Produksi benih Teripang Tril <i>Stichopus hermannii</i> Melalui Reproduksi Aseksual.	KEMENRISTEK-DIKTI	58

* Tuliskan sumber pendanaan baik dari skema penelitian DIKTI maupun dari sumber lainnya.

D. Pengalaman Pengabdian Kepada Masyarakat dalam 5 Tahun Terakhir

No.	Tahun	Judul Pengabdian Kepada Masyarakat	Pendanaan	
			Sumber*	Jumlah (juta Rp.)
1	2010	Coastal clean-up Karimunjawa 2010 sebagai upaya konservasi lingkungan laut di Kepulauan Karimunjawa	FPIK Undip	10
2	2010	I _b M Petani Pembudidaya Artemia di Tambak Garam Kec. Trangkil-Kab. Pati,	DP4M (Dikti).	10
3	2010	I _b M Kelompok produsen keripik Pisang di Pemasang,	DP4M (Dikti).	10
4	2010	I _b M Kelompok Usaha Kerupuk Ikan dan Udang di kelurahan Mangunharjo, Kecamatan Tugu, Semarang.	DP4M (Dikti).	10
5	2010	Pelibatan partisipasi masyarakat dalam rehabilitasi kawasan pesisir kritis dengan demplot hutan pantai guna penumbuhan ruang terbuka hijau dan	FPIK Undip	10

		konservasi di Marine Station Teluk Awur.		
6	2011	I _b M Kelompok Usaha Kerupuk Ikan dan Udang	DP4M (Dikti).	10
7	2012	Optimasi Pemanfaatan Tambak Tidak Produktif dan Diseminasi Konservasi Mangrove	MFF	225
8	2012	Aplikasi Pewarnaan Alam Mangrove dan Indigo untuk Bahan Batik Sebagai Diversifikasi Usaha di Desa Binaan Kabupaten Semarang.	BOPTN-FPIK UNDIP	7,5
9	2013	I _b M Kelompok Usaha Garam Rakyat di Pati.	DP2M-DIKTI-	40
10	2013	IbM Kelompok Usaha Carica di Wonosobo	DP2M-DIKTI-	50
11	2013.	I _b M Kelompok Nelayan Pembudidaya Teripang di Kepulauan Karimunjawa Jepara..	DP2M-DIKTI-	50
12	2013-2014	Collaborative Blue Swimming Crab Fishery Management in Demak..	APRI-Crab Council	200
13	2014	IbM Kelompok Petani Garam Rakyat di Rembang	DP2M-DIKTI-	45
14	2015-2016	IbPE Manisan Carica di Wonosobo Jawa Tengah	DP2M-DIKTI-	100

* Tuliskan sumber pendanaan baik dari skema pengabdian kepada masyarakat DIKTI maupun dari sumber lainnya.

E. Publikasi Artikel Ilmiah Dalam Jurnal alam 5 Tahun Terakhir

No.	Judul Artikel Ilmiah	Nama jurnal	Volume/Nomer/Tahun
1	Re-deskripsi teripang <i>Stichopus hermanii</i> dari Kepulauan Karimunjawa melalui analisa morfologi, anatomi dan spikula (ossicle).	Jurnal Kelautan Tropis.	X/2/2015
2	Penerapan Teknologi Fission pada Budidaya Teripang	INFO	XVII/2014
3	Fission Reproduction of Four Stichopudidae Species (Holothuria:Echinodermata).	Ilmu Kelautan	18/2/2013
4	Fatty acid composition of marine microalgae in Indonesia	Journal of tropical Biology and Conservation	-/10/2013
5	Stimulasi Reproduksi Aseksual Pada <i>Stichopus horrens</i> dan <i>Stichopus vastus</i> di Perairan Pulau Karimunjawa, Kabupaten Jepara	Journal Of Marine Research	1/2/2012
6	Struktur Komunitas Makrozoobenthos di perairan Pandansari Kec. Sayung, Kab, Demak	Journal of Marine Research	1/1/2012
7	Struktur Komunitas Padang Lamun di Perairan Pulau Kumbang, Kepulauan Karimunjawa.	Ilmu Kelautan	17/4/2012
8	Aplikasi teknologi tepat guna pada perbaikan mutu dan kuantitas produksi kerupuk ikan dan udang	Metana	7/1/2012

9	Kajian kadar total lipid dan kepadatan <i>Nitzschia</i> sp. yang dikultur dengan salinitas yang berbeda	Metana	7/1/2012
10	Kajian karakteristik Sedimen terhadap pola distribusi dan struktur komunitas diatom bentik di ekosistem laguna Segara Anakan Cilacap	Buletin Oseanografi Marina	1/2/2012
11	Fauna Echinodermata di <i>Indonoor Wreck</i> , Pulau Kemujan, Kepulauan Karimunjawa.	Ilmu Kelautan	16/4/2011
12	Pengaruh Pengurangan Konsentrasi Nutrien Fosfat dan Nitrat Terhadap Kandungan Lipid Total <i>Nannochloropsis oculata</i> .	Ilmu Kelautan	16/1/2011
13	Komposisi Jenis dan Kelimpahan Diatom Bentik di Muara Sungai Comal Baru Pemalang.	Ilmu Kelautan	16/1/2011

F. Pemakalah Seminar Ilmiah (Oral presentation) dalam 5 Tahun terakhir

No.	Nama pertemuan Ilmiah/Seminar	Judul Artikel Ilmiah	Waktu dan Tempat
1	International Convergence on Management Innovation and Technology In cooperation with ASEAN Uninet.	Fission Reproduction of Four Stichopodidae Species As Prospective Methods of Seed Production For Seacucumber Culture and Conservation (Holothuria : Echinodermata).	27-10-2010, Gumaya Tower Hotel Semarang
2	Indonesian Delta Forum,	Composition of macrozoobenthic and benthic diatom associated with <i>Polymesoda</i> erosa in mangrove area of Segara Anakan, Cilacap	October 21-22, 2010; Grand Candi Hotel Semarang
3	Third International Conference and Workshop on Basic and Applied Science	Community structure of phytoplankton in Plawangan, Klaces, and Donan Segara Anakan Lagoon between February-June 2005	21-23 Sept.2011 Unair & UTM Malaysia, Surabaya
4	Seminar Nasional Tahunan IX Hasil penelitian Perikanan dan Kelautan	<i>Fission Reproduction</i> Dua Spesies Teripang Ekonomis Penting Famili Stichopodidae (Holothuria : Echinodermata).	14 Juli 2012 Jur. Perikanan, Faperta, UGM,
5	Seminar Nasional Tahunan IX Hasil penelitian Perikanan dan Kelautan	Kajian Kadar Total Lipid dan Kepadatan <i>Nitzschia</i> sp. Yang Dikultur Dengan Salinitas Yang Berbeda.	14 Juli 2012 Jur. Perikanan, Faperta UGM,
6	Seminar Nasional Tahunan IX Hasil penelitian Perikanan dan Kelautan	Komposisi Makrozoobentos Di Perairan Morosari dan Pandansari, Desa Bedono, Kecamatan Sayung, Kabupaten Demak.	14 Juli 2012 Jur. Perikanan, Faperta UGM,
7	Seminar Nasional Kimia dan Pendidikan Kimia IV (SN-KPK IV),	Karakteristik Spesifikasi Biodiesel Berbahan Baku Mikroalga Laut <i>Nitzschia</i> sp	31-3-2012. FKIP UNS, Surakarta,
8	Seminar Nasional Ke II	Peril 26 <u>akan</u> Bintang Laut	4 Oktober 2012,

	Hasil-hasil penelitian Perikanan & Ilmu Kelautan Undip	<i>Protoreaster nodosus</i> .	Undip, Semarang
9	Seminar Nasional Ke II Hasil-hasil penelitian Perikanan & Ilmu Kelautan Undip	Kajian Kadar Total Lipid Dan Kepadatan <i>Nitzschia</i> Sp Yang Dikultur Dengan Salinitas Yang Berbeda.	4 Oktober 2012, Undip, Semarang
10	Seminar Nasional Ke II Hasil-hasil penelitian Perikanan & Ilmu Kelautan Undip	Pemanfaatan Air Limbah Hatchery Sebagai Media Kultur Mikroalga <i>Chaetoceros calcitrans</i> .	4 Oktober 2012, Undip, Semarang
11	Indian Ocean and Pacific Conference (IOPAC) 2013	Integrated Conservation for Food Security and Environment Resilience : Case study of two coastal village of Semarang	June 18 th – 20 th , 2013; Nusa Dua Bali,
12	1st ASEAN Congress on Mangrove Research and Development	Roles of Coastal Women Empowerment to Support Economic Development and Climate Change Adaptation at Semarang, Central Java, Indonesia.	Dec. 3–7, 2012. Century Park Hotel, Manila, Philippines on
13	Seminar Nasional Tahunan X Hasil Penelitian Perikanan dan Kelautan	Optimalisasi Total Lipid Mikroalga <i>Nannochloropsis oculata</i> Melalui Media Kultur dengan Intensitas Cahaya Yang Berbeda.	23-8-2013, Jur. Perikanan, Faperta, UGM
14	Seminar Nasional Tahunan Ke XII Hasil Penelitian Perikanan dan Kelautan	Recovery performance Teripan Trill, <i>Stichopus hermanii</i> (Stichopodidae: Holothruroidea: Echiodermata) setelah fission.	8 Agustus 2015, Universitas Gajahmada, Jogjakarta
15	Seminar Nasional Tahunan XII Hasil Penelitian dan Kelautan 2015	Kajian kandungan klorofil-a, b dan total karoten klekap di tambak bandeng Pati, Jawa Tengah	8 Agustus 2015 Fakultas Pertanian UGM
16	Seminar Nasional Tahunan XII Hasil Penelitian dan Kelautan 2015	Kajian morfologi ossicle teripang <i>Actinopyga milliaria</i> dari Karimunjawa, Jepara, Jawa Tengah	8 Agustus 2015 Fakultas Pertanian UGM
17	The 2 nd International Symposium on Aquatic Products Processing and Health	Fission as a prosperous attempt for Seacucumber <i>Pearsonothuria graeffei</i> and <i>Bohadschia similis</i> (Holothuria : Echinoderm) Conservation.	September 13-15, 2015 Diponegoro University, Semarang,
18	The 2nd International Symposium on Aquatic Products Processing and Health (ISAPPROSH)	Nutritional Value of Sea Cucumber <i>Paracaudina australis</i>	13-15 September 2015 FPIK UNDIP
19	Workshop Pengumpulan Data jenis Ikan Dilindungi Dan/Atau Terancam Punah di	Jenis-jenis teripang dari Kepulauan Karimunjawa dan Perairan Jepara (20(27 15).	23-25 November 2015, Hotel

wilayah ADB,	Padjadjaran Suite Bogor
--------------	-------------------------

G. Karya Buku dalam 5 Tahun terakhir

No.	Judul Buku	Tahun	Jumlah Halaman	Penerbit
1	Pembenihan dan pembesaran Teripang Pasir (Echinodermata: Holothuroidea).	2009	128	Badan penerbit Universitas Diponegoro. Semarang
2	Teripang (Holothuroidea : Echinodermata) di Indonesia : Biologi, Budidaya dan Konservasinya.	2009	72	Navila Idea Yogyakarta.
3	Mikroalga Laut	2009	141	Badan penerbit Universitas Diponegoro Press.

H. Perolehan HKI dalam 5-10 Tahun terakhir

No.	Judul/tema HKI	Tahun	Jenis	Nomor P/ID
-	-	-	-	-

I. Pengalaman Merumuskan Kebijakan Publik/Rekayasa Sosial Lainnya dalam 5 Tahun Terakhir

No.	Judul/tema/jenis Rekayasa Sosial Lainnya yang telah diterapkan	Tahun	Tempat Penerapan	Respon masyarakat
-	-	-	-	-

J. Penghargaan dalam 10 tahun Terakhir (dari pemerintah, asosiasi atau institusi lainnya)

No.	Jenis penghargaan	Institusi Pemberi Penghargaan	Tahun
1	SATYALANCANA KARYASATYA XX TAHUN	Presiden RI	2 Mei 2008
2	Sertifikat Pendidik	Depdiknas	25 Nop. 2008
3	Penyaji poster terbaik	Depdiknas	18 Oktober 2014

Semua data yang saya isikan dan tercantum dalam biodata ini adalah benar dan dapat dipertanggungjawabkan secara hukum. Apabila di kemudian hari ternyata dijumpai ketidaksesuaian dengan kenyataan, saya sanggup menerima sanksi.

Semarang, Desember 2018
Ketua Peneliti,



(Ir. Retno Hartati, MSc.)
NIP 19620711 198703 2 001

Curriculum vitae of Research Team 1**DAFTAR RIWAYAT HIDUP**

- 1 Nama : Prof. Dr. Ir. Muhammad Zainuri, DEA
 2 Tempat, tanggal lahir : Semarang, 13 Juli 1962
 3 NIP : 19620713 198703 1 003 / 0013076210
 4 Pangkat/Golongan : Pembina Utama Madya / IV D
 5 Jabatan Fungsional : Guru Besar
 6 Jenis Kelamin : Laki - laki
 7 Unit Kerja : Fakultas Perikanan dan Ilmu Kelautan, Program Studi Oseanografi
 8 Alamat Kantor : Gedung Widya Puraya, Jalan Prof. Soedarto, SH., Semarang. 50275
 9 Alamat Rumah : Jalan Mangga Dalam No. 7 Lamperkidul, Semarang. 50249
 10 Nama Isteri : Ir. Hj. Hadi Endrawati, DESU
 11 Nama Anak : 1. Ruminatih Parmida Nurendra Pradana (Almh.)
 2. Demashetareza Nurendra Nuzululamanullah
 3. Adhityadeva Nurendra Trifathrisna
 4. Azharaysha Nurendra Deltaverona Mahardika

RIWAYAT PENDIDIKAN FORMAL

No.	Perguruan Tinggi	Tahun Lulus	Bidang Keahlian	Judul Skripsi/Thesis/Disertasi
1.	Universitas Diponegoro	1986	Perikanan	Studi perbandingan pertumbuhan postlarva (PL – 25) Udang Windu (<i>Penaeus monodon</i> Fabricius) Normal dan Ablasi Mata dengan pemberian Jumlah makanan Buatan Yang Berbeda
2.	Universite des Sciences et Techniques du Languedoc, Montpellier - France,	1989	Diplome d'Etudes Approfondie Sciences de l' Evolutions et Ecologie	Age, Croissance et Reproduction du Sandre (<i>Stizostedion lucioperca</i>) du Camargue, Mediterranean, Sud de France
3.	Universite de Montpellier II - Sciences et Techniques du Languedoc, Montpellier - France	1993	Doctorat de Biologie de Population et Ecologie	Structures des peuplements ichtyofauniques d'une zone d'herbier à <i>Zostera marina</i> de l'étang de Thau (France). Etude de la composition alimentaire des juvéniles du loup (<i>Dicentrarchus labrax</i> , Linnaeus 1758), de la daurade (<i>Sparus aurata</i> , Linnaeus 1758) et du muge (<i>Chelon labrosus</i> , Risso, 1826) par des approches expérimentales

RIWAYAT KEPANGKATAN

No.	Pangkat	Golongan	TMT
1.	Penata Muda (CPNS)	III A	1 Maret 1987
2.	Penata Muda (PNS)	III A	1 Mei 1988
3.	Penata Muda Tk. I	III B	1 Mei 1995
4.	Penata	III C	1 April 1997
5.	Penata Tk I	III D	1 Oktober 2000
6.	Pembina	IV A	1 Oktober 2002
7.	Pembina Tk I	IV B	1 April 2007
8.	Pembina Utama Muda	IV C	1 Oktober 2009
9.	Pembina Utama Madya	IV D	1 Oktober 2011

RIWAYAT JABATAN FUNGSIONAL

No.	Jabatan	TMT
-----	---------	-----

1.	Asisten Ahli	1 Nopember 1994
2.	Lektor Muda	1 Nopember 1996
3.	Lektor Madya	1 Juli 2000
4.	Lektor	1 Januari 2001
5.	Lektor Kepala	1 September 2002
6.	Guru Besar	1 Juli 2010

JUDUL PIDATO PENGUKUHAN

Kontribusi Sumberdaya Fitoplankton terhadap Produktivitas dan Keseimbangan Ekosistem dalam Pengelolaan Wilayah Pesisir

TRAINING, WORKSHOP, DAN BENCHMARKING

No.	KEGIATAN	TEMPAT	TAHUN
1.	Media Komunikasi	Universitas Diponegoro	20 – 23 Desember 1993
2.	PEKERTI	Universitas Diponegoro	17 – 24 Januari 1995
3.	Metodologi Pengabdian Kepada Masyarakat	Lembaga Pengabdian Kepada Masyarakat UNDIP	21 – 27 April 1995
4.	Dosen Wali	Lembaga Pengembangan Pendidikan UNDIP	27 – 29 April 2000
5.	Entrepreneurship	Lembaga Pengembangan Pendidikan UNDIP	I. 1 – 15 Maret 2000
6.	Bahasa Perancis – Formation Linguistique et Socioculturelle	Bureau d'Action Linguistique, Ambassade de France en Indonesie	II. 19 Oktober 1987 – 25 Maret 1988
7.	Bahasa Perancis – Diplome Elementaire de Langue Francaise (A 1 , A4, A5)	Ambassade de France en Indonesie	7 – 9 Mars 1988
8.	Bahasa Perancis – Cours de Langue et Litterature Francaise	Cours d'Ete de Quimper, France	4 – 29 Juillet 1988
9.	Biometrica et Ecologie (BIOMEKO)	EPHE – CNRS, Montpellier France	10 – 12 Avril 1989
10.	AMDAL A	PPLH – Lemlit UNDIP	17 – 19 Januari 1994
11.	AMDAL B	PPLH – Lemlit UNDIP	4 April – 20 Mei 1994
12.	Water Safety Program	Mc Master University	May, 5 – July, 2, 1995
13.	Marine Science Management and Resource	WUSC Canada	May, 5 – July, 2, 1995
14.	Kursus Bahasa Jepang	UPT Bahasa Asing UNDIP	4 September – 30 Oktober 1995
15.	Agriculture Higher Education Administrator Development (AHEAD)	SEAMEO – SEARCA Philippines	16 – 27 September 1996
16.	Regional Workshop on Ecology of Tropical Mesozooplankton and Fish Larvae	Phuket Mar. Bio. Center, Thailand	15 – 23 November 2000

PENGALAMAN ORGANISASI

No.	Nama Organisasi	Jabatan	Tahun
1.	Ikatan Alumni Prancis Indonesia	Anggota	1994 - sekarang
2.	Ikatan Amdalis Indonesia	Anggota	1994 - sekarang

3.	Kelompok Peneliti Dinamika Atmosfir LAPAN Bidang Interaksi Laut – Atmosfir	Anggota	17 Juli 1995 - sekarang
4.	Ikatan Alumni (IKA) UNDIP	Anggota	1997
5.	Ikatan Sarjana Oseanologi Indonesia (ISOI)	Anggota	2003
6.	Sertifikat Pendidik No. 08100803765, Departemen Pendidikan Nasional	Dosen Profesional	25 Oktober 2008 - sekarang
7.	Persatuan Insinyur Indonesia (PII)	Dewan Pakar Bidang Kelautan	2012 - 2015

PENGALAMAN MANAGERIAL

No.	Jabatan	Tahun
1.	Asisten Sekretaris Bidang Administrasi Akademis dan Penelitian BP Prog. Studi Ilmu Kelautan	1 Desember 1994 – 30 Agustus 1995
2.	Ketua Program Studi Ilmu Kelautan BP Program Studi Ilmu Kelautan	1 September 1995 – 31 Januari 1996
3.	Pembantu Dekan Bidang Akademis Fakultas Perikanan dan Ilmu Kelautan	1 Pebruari 1996 – 29 Pebruari 2000
4.	Staf Ahli Pembantu Rektor Bidang Pengembang an dan Kerjasama Universitas Diponegoro	1 Agustus 2000 – 31 Desember 2006
5.	Kepala Laboratorium Biologi Kelautan	1 Juni – 31 Desember 2001
6.	Ketua Program Studi Oseanografi, Jur Ilmu Kelautan, Fak Perikanan dan Ilmu Kelautan Univ. Diponegoro	14 September 2001 – 31 Des. 2006
7.	Tim Pendamping/Review Internal Tingkat Universitas untuk PHK DUE LIKE BATCH III	2002
8.	Tim Pendamping/Review Internal Tingkat Universitas untuk PHK TPSDP	2002
9.	Asisten Direktur Kurikulum, Akademik dan Kesekretariatan, Prg DUE Like Batch III UNDIP	1 Januari 2002 – 31 Desember 2006
10.	Tim Pendamping/Review Internal Tingkat Universitas untuk PHK SEMI QUE IV	2003
11.	Tim Pendamping/Review Internal Tingkat Universitas untuk PHK TPSDP	2003
12.	Tim Pendamping/Review Internal Tingkat Universitas untuk PHK SEMI QUE V	2004
13.	Tim Pendamping/Review Internal Tingkat Universitas untuk PHK A2 dan A3	2004
14.	Anggota Senat Fakultas Perikanan dan Ilmu Kelautan UNDIP	1 Desember 2004 - sekarang
15.	Tim Pendamping/Review Internal Tingkat Universitas untuk PHK A1, A2 dan A3	2005
16.	Tim Pendamping/Review Internal Tingkat Universitas untuk PHK IMHERE	2005
17.	Direktur PMU Akademik Proyek IDB UNDIP	1 Juni – 31 Desember 2006
18.	Asesor Nasional untuk Program Hibah Kompetisi	2006 - 2010
19.	Ketua Program Studi Oseanografi, Jur Ilmu Kelautan, Fak Perikanan dan Ilmu Kelautan Univ. Diponegoro	2 Januari 2007 – 31 Oktober 2011
20.	Reviewer Nasional untuk Penelitian	2010 - sekarang
21.	Anggota Senat Universitas Diponegoro, Komisi IV	1 Oktober 2010 - sekarang
22.	Reviewer Nasional untuk Program Ditbelmawa	2012 - sekarang
23.	Dekan Fakultas Perikanan dan Ilmu Kelautan Universitas Diponegoro	1 Nopember 2011 – 31 Mei 2015
24.	Reviewer Nasional untuk Pusat Unggulan IPTEK	2014 - 2015
25.	Reviewer Nasional untuk Program Hibah PTS	2015
26.	Pembantu Rektor Bidang Akademis	3 Juni 2015 -

PENGALAMAN PENELITIAN

No.	Judul	Sumber Dana	Kedudukan dalam Penelitian	Tahun
1.	Identifikasi dan Kelimpahan Zooplankton di Padang Lamun <i>Zostera marina</i> , Perairan Teluk Awur, Jepara	Lemlit UNDIP OPF No. 201/XXIII /3/1994 28/3/1994	Ketua	1994
2.	Studi Lingkungan dan Sosial Ekonomi Wilayah Pesisir dan Laut Madura – Kangean	COREMAP PPLH Lemlit UNDIP	Anggota	1995
3.	Keanekaragaman Hayati Produser Sekunder pada Beberapa Habitat dan Ekosistem di Perairan Jepara.	III. DIK-RUTIN No. 121/J07/PJJ/KP/2000	Anggota	2000
4.	Produksi Astaksantin oleh <i>Phaffia rhodhozyma</i> sebagai Pigmen Penting dalam Akua-kultur pada Media Molase	DCRG–URGE No. 015/ DCRG /URGE/2000	Anggota	2001
5.	Paket Teknologi Penggunaan Khamir <i>Phaffia rhodhozyma</i> sebagai Sumber Pigmen Karotenoid dalam Upaya Diversifikasi Pakan Buatan pada Sektor Akulkultur	No. 15/P2IPT /DPPM/PHBL/III/2002, 27 Maret 2002	Anggota	2002
6.	Paket Teknologi Penggunaan Khamir <i>Phaffia rhodhozyma</i> sebagai Sumber Pigmen Karotenoid dalam Upaya Diversifikasi Pakan Buatan pada Sektor Akulkultur	No. 15/P2IPT /DPPM/PHBL/III/2003, 27 Maret 2003	Anggota	2003
7.	Komponen Nutritif pada Copepoda sebagai Pakan Alami Biota Laut : Kajian Bioenergitik	Dirjen Dikti, Depdik-nasNo. 16/P2IPT /DPPM /PID/III/2003	Ketua	2003
8.	Variabilitas Spasial Biomassa dan Morfologi Daun Lamun <i>Enhalus</i> sp. di Perairan Jepara	Dirjen Dikti, No. 028/P4T/ DPPM/ PDM /III/2003	Anggota	2003
9.	Studi Eksploitasi dan Eksplorasi Sumberdaya Hayati (<i>Enhalus</i> sp., <i>Acartia</i> sp. dan <i>Psettooides erumei</i>) Laut Perairan Jawa	Proyek DUE LIKE Batch III Undip No 16/ J.07.DUE Like III/KP/ 2003	Ketua	2003
10.	Rekayasa Paket Tehnologi Produksi Pakan Alami Copepoda Pada Sistim Kultivasi Pembenuhan Ikan Kerapu (<i>Epinephelus</i> sp.) Skala Backyard	HIBAH BER-SAING TH 1 HIBAH BER-SAING TH 2	Anggota	2005
11.	Pelacakan Gen Penyandi Biosintesis Karotenoid D-1-Deoksixilulosa-5-Phosphate Sintase pada Mikroalga <i>Dunaliella</i> sp. untuk Pengembangan Produksi Karotenoid	Fundamental Riset Th 1 Fundamental Riset Th II	Ketua	2006 2007
12.	Pengembangan Produksi Karotenoid dari Alga <i>Dunaliella</i> dan Khamir <i>Phaffia rhodozyma</i> melalui Teknik Fusi Protoplasma untuk Diversifikasi Pakan Akuakultur	HIBAH BERSAING Tahun I	Ketua	2009
13.	Deteksi Potensi Blooming Mikroalga dan Pembentukan Sel	Hibah Penelitian Multi Tahun No.	Anggota	2009

	Heterotrofnya melalui Bioteknologi untuk Produksi Biodiesel	124A/H7.2/KP/2009, 18 Maret 2009		
14.	Pengembangan Usaha Budidaya untuk Meningkatkan Pendapatan Petani Tambak melalui Diversifikasi Pakan Akuakultur dengan Kandungan Karotenoid Tinggi Hasil Fusi Protoplasma Alga <i>Dunaliella</i> dan Khamir <i>Phaffia rhodozyma</i>	Hibah Bersaing	Anggota	2010-2012
15.	Aplikasi Pakan Alami Kaya Karotenoid dari Mikroalga Hasil Fusi Protoplas <i>Dunaliella</i> dan <i>Chlorella</i> untuk Meningkatkan Ketahanan Penyakit pada Larva Udang Windu (<i>Penaeus monodon</i> Fabricius)	Hibah Bersaing	Anggota	2013 - 2015
16.	Produksi, Pengembangan dan Aplikasi Pakan Akuakultur Multitarget kaya nutrisi untuk mendukung Program Ketahanan Pangan	Hibah Penelitian Pasca Sarjana	Ketua	2014 - 2016
17.	Sustainable Valorization of Indonesian Phytoplankton Aquaculture : New Approaches to Control Infectious Diseases	International Reserach Collaboration and Scientific Publication	Anggota	2014 - 2016

PENGALAMAN PENGABDIAN MASYARAKAT

No	Judul	Kedudukan	Tahun	Sumber Dana
1.	Penyuluhan tentang pola hidup udang Putih (<i>Penaeus merguensis</i>) dan udang Windu (<i>Penaeus monodon</i>) serta seleksi penangkapannya guna pelestarian sumber daya hayati laut di Kecamatan Kedung, Kab. Jepara	Anggota	1996	Lembaga Pengab. Masyarakat UNDIP OPF No. 26c/PT09.OP/T/1996 8 Mei 1996
2.	Introduksi Pembesaran Kepiting Bakau sebagai Alternatif Pengganti Usaha Budidaya Udang di Desa Panggung Kecamatan Kedung Kabupaten Jepara	Anggota	1996	Lembaga Pengabdian Masyarakat UNDIP OPF No. 322a/ PT 09.H11/C/1996 5-8-1996 Mandiri
3.	Pembinaan Kegiatan Remaja dalam Bidang Budidaya Perikanan di Desa Rejosari, Kec. Brangsong Kabupaten Kendal	Anggota	Juni – Desember 1996	
4.	Introduksi Pembesaran Kepiting Bakau sebagai Alternatif Pengganti Usaha Budidaya Udang Desa Panggung Kedung Jepara	Anggota	Agustus 1996 – Maret 1997	ST Ketua LPM No. 322 ^a /PT09 .H11/C/1996 5 /08/1996
5.	Penyuluhan dan Pelatihan Pemasya-rakatan teknologi pembesaran ikan nila merah sebagai diver-sifikasi udang ditambak. Desa Panggung Kedung Jepara	Anggota	1 Juli – 30 Desember 1998	Lembaga Pengabdian kepada Masyarakat UNDIP DIK Rutin No. 061/23/1998 1 April 1998

6.	Penyuluhan dan Pelatihan Pemanfaatan pekarangan untuk Budidaya ikan skala rumah tangga Desa Candisari Secang Magelang	Anggota	September 1997 – Pebruari 1998	Lembaga Pengabdian Masyarakat UNDIP DIK Rutin
7.	Paket Penerapan paket teknologi produksi garam dan budidaya polikultur dalam rangka pemberdayaan petani garam / tambak untuk menanggulangi dampak krisis ekonomi, optimalisasi sumberdaya pesisir serta pelaksanaan otonomi daerah di Kabupaten DATI II Jepara	Anggota	2001	SEMI QUE III PMPT – DPT No. P.006.171/ P2MPT/2001/SQ
8.	Pemasyarakatan Teknologi Budidaya Monokultur Ikan Nila Gift di Tambak Dalam Upaya Pemberdayaan Masyarakat Pantai di Desa Binaan	Anggota	2002	IPTEK No. 01/J07.18/KPP/2002
9.	Optimalisasi Kultivasi Rumput Laut (<i>Gracilaria sp</i>) Sebagai Agen Biofilter Muatan Padatan Tersuspensi dan Peningkatan Kualitas Air Tambak Tradisional Pada Kultur Bandeng (<i>Chanos chanos</i> Forskal) di Kecamatan Sayung, Kodya Semarang	Ketua	2004	PP UNDIP – SP Penelitian Prog. Vucer dan Penerapan IPTEK No : 02/J07.18/KPP/2004
10.	Transplantasi Mangrove (<i>Avicennia sp</i> dan <i>Rhizophora sp</i>) guna Pengatasan Banjir, Perbaikan Lingkungan Pematang dan Produktivitas Tambak Pada Kultur Bandeng (<i>Chanos chanos</i> Forskal) di Kecamatan Sayung, Kabupaten Demak	Anggota	2005	APBN UNDIP – SPTPP Vucer & Penerapan IPTEK, No : 08/J07/PM/2005
11.	Teknologi Biofilter Rumput Laut (<i>Gracillaria sp.</i>) Floating Cage untuk Peningkatan Kualitas Air Tambak Tradisional pada Kultur Bandeng (<i>Chanos chanos</i> Forskal) di Kecamatan Sayung, Kabupaten Demak	Anggota	2005	Program Teknologi Tepat Guna. Din. Dik. Bud Prop. Jawa Tengah
12.	Teknologi Integrated Biofilter Rumput Laut (<i>Gracillaria sp.</i>) Floating Cage dengan Silvokultur untuk Peningkatan Kualitas Air Tambak Tradisional pada Kultur Bandeng (<i>Chanos chanos</i> Forskal) di Kecamatan Sayung, Kabupaten Demak.	Ketua	2006	Program Teknologi Tepat Guna. Din. Dik. Bud Prop. Jawa Tengah
13.	Optimalisasi Floating Cage pada Kultivasi Rumput Laut (<i>Gracillaria sp.</i>) Terhadap Peningkatan Kualitas Air Tambak Tradisional pada Kultur Bandeng (<i>Chanos chanos</i> Forskal) di Kecamatan Sayung, Kabupaten Demak.	Ketua	2006	Program Vucer DP2M No : 690/J07. P2/KU/2006, 20 Maret 2006
14.	Kaji Terap Teknologi Budidaya Ikan Nila Gift di Tambak Sebagai Upaya Penanggulangan Rawan Gizi dan Kemiskinan Pasca Tsunami	Anggota	2009	Program Penerapan IPTEKS No. 205/SP2H/PPM/DP2M/IV/2 009, 22/4/2009 & SK Rektor No. 371/SK/ H7/ 2009,

22/7/2009

15.	Penghijauan Tanaman Keras di Wilayah Pantai Teluk Awur Jepara dalam Upaya untuk Menahan angin Laut Baratan dan Keindahan Kampus	Anggota	2014	SKMT FPIK No. 472/UN7.3.10/KP/2014
16.	Membangun Interaksi antara Kelompok Nelayan dengan Dinas Kelautan dan Perikanan Kabupaten Jepara dalam Aplikasi Teknologi Peramalan Waktu dan Daerah Potensi Ikan	Anggota	2015	SKMT FPIK No. 910/UN7.3.10/KP/2015
17.	Penguatan Nilai Tambah Komoditi Perikanan Budidaya di Kabupaten Sumedang melalui Penerapan Asap Cair	Anggota	2016	SP DIPA 042.01.2.400898/2016 7 Desember 2015
18.	IbM Kelompok Wanita Pesisir Produsen Garam Rebus di Kabupaten Brebes	Anggota	2016	DRPM No 008/SP2H/PPM/DRPM/II/2 016 17 Februari 2016

PENGALAMAN MENGAJAR

No.	Mata Kuliah	Unit Kerja	Tahun
1.	Pengantar Oseanografi	PS S1 Oseanografi FPIK Undip	GS 2016/2017
2.	Oseanografi Biologi	PS S1 Oseanografi FPIK Undip	GS 2016/2017
3.	Metoda Penelitian / TPTI	PS S1 Oseanografi FPIK Undip	GS 2016/2017
4.	Planktonologi	PS S1 Ilmu Kelautan FPIK Undip	GS 2016/2017
5.	Statistika Terapan	PS S2 Magister Ilmu Kelautan FPIK Undip	GS 2016/2017
6.	Metodologi Penelitian	PS S3 Doktor Manajemen SD Pesisir FPIK Undip	GS 2016/2017
7.	Biologi / Zoologi Laut	PS S1 Oseanografi FPIK Undip	GN 2016 / 2017
8.	AMDAL	PS S1 Oseanografi FPIK Undip	GN 2016 / 2017
9.	Manajemen Sbdy Pesisir dan Laut	PS S1 Oseanografi FPIK Undip	GN 2016 / 2017
10.	Biologi Populasi	PS S2 Magister Ilmu Kelautan FPIK Undip	GN 2016 / 2017
11.	Mitigasi Bencana	PS S3 Doktor Ilmu Kelautan FPIK Undip	GN 2016 / 2017

PUBLIKASI ILMIAH

- A. Jurnal Ilmiah/ Jurnal International
- Borsa, P., **M. Zainuri** & B. Delay. 1991. Heterozygote deficiency and population structure in the bivalve, *Ruditapes decussates*. *Heredity*, 66 (1-8).
 - Wongrat, L., N. Cho, M.U. Gauns, **M. Zainuri**, I. Phromthong, B. Sikhantakasamit & M. Kaewsiang, 2002. Feeding and Production of Copepod in the Andaman Sea. *Phuket Marine Biological Center Special Edition* 27 : 14-17, 2002
 - Pancasakti, H. P., & **M. Zainuri**. 2014. Stability of Total Pigments Production of Fusan from Protoplast Fusion of Microalgae *Dunaliella* dan *Chlorella in vivo* : Attempts on Production of Sustainable Aquaculture Natural Food. *International Journal of Marine and Aquatic Resource Conservation and Co-existence (IJMARCC)* 1 (1):1-5 ISSN 2406-9094
 - Susilowati, T., J. Hutabarat, S. Anggoro & **M. Zainuri**. 2014. The Improvement of the Survival, Growth and Production of Vaname Shrimp (*Litopenaeus vannamei*) and Seaweed (*Gracillaria verrucosa*) based on Polycultuyre Cultivation. *International Journal of Marine and Aquatic Resource Conservation and Co-existence (IJMARCC)* 1 (1):6-11 ISSN 2406-9094
 - Sulistiyowati, **M. Zainuri**, A. N. Bambang & A. Suryanto, 2014. Shrimp (*Penaeus* spp.) Potential, Utilization and Management Effort at Batang District Coastal Waters. *International Journal of Marine and Aquatic Resource Conservation and Co-existence (IJMARCC)* 1 (1):27-32 ISSN 2406-9094
 - Pancasakti, H. P., & **M. Zainuri**. 2015. Detection of Bacteria and Fungi Associated with *Penaeus monodon* Postlarvae Mortality. *International Conference on Tropical and Coastal Region Eco-Development 2014 (ICTCRED 2014)*. Procedia, Environmental Sciences. Science Direct. *Procedia Environmental Sciences* 23 (2015) : 329-337
 - Zainuri, M**, Sunaryo & H. P. Kusumaningrum. 2015. Production of Microalgae *Dunaliella* and *Chlorellain vivoto* Support Sustainable Aquaculture Natural Food. *International Journal of Marine and*

Aquatic Resource Conservation and Co-existence (IJMARCC) 1 (2):1-6 ISSN 2406-9094

8. Helena, S., **M. Zainuri** & J. Suprijanto. 2015. Microalgae *Dunaliella salina* Growth Using the LED (Light Emitting Diode) Light and Different Media Types.. 2nd International Symposium on Aquatic Products Processing and Health. (ISAPPROSH 2015). Aquatic Procedia. Science Direct. Aquatic Procedia (2016) : www.elsevier.com/locate/procedia
9. Satriaji, D. E., **M. Zainuri** & I. Widowati. 2015. Study of Growth and C, N, P Content of Microalgae *Chlorella* sp. Cultivated in Different Culture Media and Light Intensity. 2nd International Symposium on Aquatic Products Processing and Health. ISAPPROSH 2015. Aquatic Procedia. Science Direct. Aquatic Procedia (2016) : www.elsevier.com/locate/procedia
10. **Zainuri, M.**, Sunaryo & H. P. Kusumaningrum. 2016. Tiger Shrimp (*Penaeus Monodon Fabricius*), and Whiteleg Shrimp Postlarvae (*Litopenaeus Vannamei*) Growth Performance Fed and Microalgae *Dunaliella Salina*, *Chlorella Vulgaris* and Enrichment Nutrient Artificial Food. International Conference on Tropical and Coastal Region Eco-Development (ICTCRED) 2016.
11. Ismanto, A., **M. Zainuri**, Sahala Hutabarat & Denny Nugraha. 2016. Sediment Transport Model in Sayung District, Demak. International Conference on Tropical and Coastal Region Eco-Development (ICTCRED) 2016.
12. Fadlan, Ahmad, Denny Nugroho Sugianto & **M. Zainuri**. 2016. Influence of Enso and TO Variability of Sea Surface Height in the North and South of Java Island. International Conference on Tropical and Coastal Region Eco-Development (ICTCRED) 2016.
13. Widianingsih, **M. Zainuri**, & Sutrisno Anggoro. 2016. Proximate Content of “KLEKAP” (Microphytobenthos and Their Associated Meiofauna) From Milk-Fish Pond. International Conference on Tropical and Coastal Region Eco-Development (ICTCRED) 2016.
14. Haryanto, Yosafat Donni, Novi Fitrianti, Agus Hartoko, Sutrisno Anggoro, & **M. Zainuri**. 2016/ MJO (Madden-Julian Oscillation) Analysis of the Chlorophyll-A Distribution in Western Waters Bengkulu. International Conference on Tropical and Coastal Region Eco-Development (ICTCRED) 2016.
15. Widianingsih, **M. Zainuri**, Sutrisno Anggoro & Hermin Pancasakti Kusumaningrum. 2016. Nutritional Value of Sea Cucumber (*Paracaudina australis* (Semper, 1868)). *Aquatic Procedia* 7 :217 – 276
16. Widowati, I., **M. Zainuri**, H P Kusumaningrum, R. Susilowati, Y. Hardivillier, V. Leigne;, N. Bourgougnon & J. L. Mouget. Antioxidant activity of three microalgae *Dunaliella salina*, *Tetraselmis chuii* and *Isochrysis galbana* clone Tahiti. 2nd Inter. Conf. On Tropic. And Coast. Dev. IOP Conf. Series. Earth and Env. Sciences 55 (2017)

B. Seminar Internasional

1. Kusumaningrum H.P., **Zainuri M.**, M. Helmi dan H. Endrawati. 2008. Polder Tawang Semarang : Study Case of Biotechnical Application and Waste Water Treatment as Part of Integrated Coastal Management. Makalah disajikan Pada 2008 International Conference of Geomatic, Fisheries and Marine Sciences for A Better Future and Prosperity : Diponegoro Univ. – Patra Convention Hotel, Semarang, October 21-23th, 2008
2. **Zainuri M.**, H. P. Kusumaningrum, dan E. Kusdiyantini. 2009. Intraspecies Protoplast Fusion Process of *Dunaliella salina*. Poster presented at National Indonesia Congress 10th Society Microbiology and International Symposia. Indonesia Society for Microbiology. JW Mariot Hotel Surabaya, November 20-21st.

C. Jurnal Nasional

Jurnal Nasional Terakreditasi (Penulis Pertama)

1. **Zainuri, M.,**E. Kusdiyantini, Widjanarko,J. Soedarsono and T. Yuwono. 2003. Preliminary Study on the Use of Yeast *Phaffia rhodozyma* as pigment source on the Growth of Tiger Shrimp (*Penaeus monodon* Fabricius). *Ilmu Kelautan* 8 (1) : 47-52
2. **Zainuri, M.,** E. Kusdiyantini, Widjanarko,J. Soedarsono and T. Yuwono. 2003. Study of Yeast *Phaffia rhodozyma* as Pigment Source to The Carotenoid Contents of Tiger Shrimp (*Penaeus monodon* Fabricius). *Ilmu Kelautan* 8 (2) : 109 – 113
3. **Zainuri, M.,** H. Endrawati, Widianingsih dan Irwani, 2008. Produktivitas Biomassa Copepoda di Perairan Demak. *Ilmu Kelautan* 13 (1) : 19-24
4. **Zainuri, M.,** H. P. Kusumaningrum and E. Kusdiyantini. 2008. Microbiological and Ecophysiological Characterisation of Green Algae *Dunaliella* sp. for Improvement of Carotenoid Production. *Jurnal Natur Indonesia* 10 (2) : 66-69
5. **Zainuri, M.,**H. Endrawati, H. P. Kusumaningrum and E. Kusdiyantini. 2008. Konsumsi Harian Copepoda terhadap Pakan *Chlorella* sp. pada Volume Media Kultivasi yang Berbeda. *Ilmu Kelautan* 13 (3) : 121-126.

Jurnal Nasional Terakreditasi (Penulis Anggota)

1. Endrawati H., **M. Zainuri**& Hariyadi. 2000. The Abundance of zooplankton as Secondary Producer at Awur Bay in the Northern Central Java Sea. *Journal of Coastal Development* 4 (1) : 481 – 489.
2. Endrawati H., **M. Zainuri**, I. Samidjan & A. Indardjo. 2001. Polikultur Udang Windu (*Penaeus monodon*) dan Nila Gift (*Oreochromis niloticus*) di tambak garam tradisional. *Ilmu Kelautan* VI (21) : 34–43,
3. Endrawati H., **M. Zainuri**, C. A. Suryana dan Suryono. 2003. Pengaruh Kepadatan terhadap Pertambahan Berat dan Tingkat Kelangsungan Hidup Kepiting Bakau (*Scylla serrata*) pada Kultivasi di Tambak Garam. *Ilmu Kelautan* VIII (2) : 94 – 99.
4. Kusdiyantini, E., Widjanarko,**M Zainuri**, J. Soedarsono and T. Yuwono. 2003. Potensi Produksi Karotenoid Khamir *Phaffia rhodozyma* Dengan Sumber Karbon Glukosa dan Molase pada Fermentasi Batch untuk Akuakultur (*Penaeus monodon* Fabricius). *Ilmu Kelautan* 8 (2) : 83 – 88.
5. Facta M.,**M. Zainuri**, Sudjadi, dan E. P. Sakti. 2006. Pengaruh Pengaturan Intensitas Cahaya yang Berbeda Terhadap Kelimpahan *Danaliella* sp. dan Oksigen Terlarut dengan Simulator TRIAC dan Mikrokontroller AT89S52. *Ilmu Kelautan* 11 (2) : 67-71.
6. Endrawati H., **M. Zainuri**, E. Kusdiyantini and H. P. Kusumaningrum. 2007. Struktur Komunitas Copepoda di Perairan Jepara. *Ilmu Kelautan* 12 (4) : 193-198
7. Endrawati H., **M. Zainuri**, E. Kusdiyantini and H. P. Kusumaningrum. 2008. Kontribusi Pakan *Chlorella* sp. dan *Tetraselmis chuii* terhadap Densitas Copepoda. *Ilmu Kelautan* 13 (1) : 43-46
8. Endrawati H., **M. Zainuri**, E. Kusdiyantini and H. P. Kusumaningrum. 2008. Pertumbuhan Juvenil Ikan Kerapu Macan (*Epinephelus fuscoguttatus*) yang dipelihara dengan Padat Penebaran Berbeda. *Ilmu Kelautan* 13 (3) : 135-140
9. Kusumaningrum, H. P., dan **M. Zainuri**. 2013. Aplikasi Pakan Alami Kaya Karotenoid untuk Post Larvae *Penaeus monodon* Fab. *Ilmu Kelautan* 18(3):143-149

C.Jurnal Nasional

1. **Zainuri M.,** 1998. Kajian Pembentukan Lapisan Opaque dan Hyalin pada Otolith Ikan Kakap(*Stizostedion lucioperca* L.) terhadap intepretasi perioda reproduksi. *Majalah Penelitian. Lemlit UNDIP*. X (40) : 52 – 57
2. **Zainuri M.,** & H. Endrawati, 1999. A Mass-Balance Trophic Flow Model at Awur Bay in the Northern Central Java Sea. *Journal of Coastal Development* 3(1), 481 - 489.
3. Hartati, R., E. Supriyo, & **M. Zainuri**. 2013. Yodisasi Garam Rakyat dengan Sistem Screw Injection. *Gema Teknologi* 17 (4):160-163 Oktober 2013 - April 2014

D. Seminar Nasional

1. **Zainuri M.,** 1990. Penerapan Analisa Gambar pada Sampel – sampel Biologi Laut (Otolith – Sisik – Zooplankton) : Sebuah Studi Awal. *dalam* Setyo Sarwanto M. dkk (ed) Prosiding Seminar Biotechnologi, PPI Perancis. Montpellier 30 Juni – 1 Juli 1990. Hal 165 – 180
2. **Zainuri M.,** 1996. Kajian Siklus Harian Kelimpahan, Keanekaragaman, dan Struktur Komunitas Zooplankton di Padang Lamun, Teluk Awur, Jepara. *dalam* Prosiding Seminar Nasional Wilayah Pantai : Aspek Manajemen dan Dinamika Biogeofisik.

Oktober 1996

3. Rustam, A dan **Zainuri M.**, 1996. Demographic structure of bivalvae at Rembang Waters. *dalam Tropical Marine Mollusc Workshop Proceeding*, Jepara. November, 1996
4. **Zainuri M.**, H. Endrawati, R. Hartati dan Widianingsih. 2004. Studi Eksploitasi dan Eksplorasi Sumberdaya Hayati Hayati (*Enhalus sp.*, *Acartia sp.* dan *Psettooides erumei*) Laut Perairan Jawa. Makalah disajikan Pada Seminar Hibah DUE Like Batch III Universitas Diponegoro : Semarang, 8 April 2004
5. **Zainuri M.**, H. Endrawati dan H. P. Kusumaningrum. 2004. Komponen Nutritif pada Copepoda sebagai Pakan Alami Biota Laut : Kajian Bioenerjitik. Makalah disajikan Pada Seminar Nasional Hasil Penelitian Dasar Tahun 2003 : Jakarta, 12-14 Juli 2004
6. **Zainuri M.**, E. Kusdiyantini dan Widjanarko. 2004. Paket Teknologi Penggunaan Khamir *Phaffia rhodozyma* Sebagai Sumber Pigmen Karotenoid dalam Upaya Diversifikasi Pakan Buatan pada Sektor Akuakultur. Makalah disajikan Pada Seminar Nasional Hasil Penelitian Hibah Bersaing Tahun 2003 : Jakarta, 27 - 29 Juli 2004
7. **Zainuri M.**, H. Endrawati dan A. Indardjo. 2005. Optimalisasi Kultivasi Rumput Laut (*Gracillaria sp.*) Sebagai Agen Biofilter Muatan Padatan Tersuspensi dan Peningkatan Kualitas Air Tambak Tradisional pada Kultur Bandeng (*Chanos chanos* Forskal) di Kec. Sayung, Kab. Demak. Makalah disajikan Pada Seminar Nasional Hasil Program Penerapan IPTEKS dan Vucer Tahun 2004 : Jakarta, 27 - 29 Juni 2005
8. Kusumaningrum H.P., **Zainuri M.**, dan A. Prasetyaningrum, 2010. Deteksi Potensi Blooming Mikroalga dan Pembentukan Sel Heterotrofnya melalui Bioteknologi untuk Produksi Biodiesel. Seminar Nasional Hasil Penelitian Tahun 2009 : Jakarta, 29-30 Juli 2010
9. Widianingsih, M. Zainuri, S. Anggoro & H.P Kusumaningrum. Kajian Kandungan Klorofil A, B dan Total Karoten pada Klekap di Tambak Bandeng, Pati, Jawa Tengah. Seminar Nasional Tahunan XII Hasil Penelitian Perikanan dan Kelautan. 8 Agustus 2015. Semnaskan_UGM / Rekayasa Budidaya (RB – 16) : 253 - 257

Semua data yang saya isikan dan tercantum dalam biodata ini adalah benar dan dapat dipertanggungjawabkan secara hukum. Apabila di kemudian hari ternyata dijumpai ketidaksesuaian dengan kenyataan, saya sanggup menerima sanksi.

Semarang, 1 Desember 2018



Nama : Prof. Dr. Ir. Muhammad Zainuri, DEA
NIP : 19620713 198703 1 003

Curriculum vitae Anggota Peneliti 2

BIODATA

KETERANGAN UMUM

1. Nama Lengkap	Prof. Dr. Ir. Ambariyanto, MSc	
2. NIP/NIDN/Pendidik	131771275 / 196104131988031002 / 0013046102 / 08100803767	
3. Pangkat/ Gol./Jab.	Pembina Utama Madya/ IVD / Guru Besar	
4. Tanggal lahir	13 April 1961	
5. Tempat lahir	Klaten	
6. Fakultas/Jurusan	Fakultas Perikanan dan Ilmu Kelautan / Ilmu Kelautan	
7. Alamat Kantor	Jl Prof Sudarto SH. Kampus FPIK UNDIP Tembalang Semarang	
8. Telp./Fax.	024 7474 698	
9 .Alamat	Cempedak Selatan No 2, Semarang 50249	
9. Alamat	a. Jalan	
	b. Desa	Lamper Kidul
	c. Kec.	Semarang Selatan
	d. Kab/kota	Semarang 50249
	e. Propinsi	Jawa Tengah
10. Telp	a. Rumah	024 8311 543
	b. HP	081 5656 5278
	c. e-mail	ambariyanto@undip.ac.id ; ambariyanto.undip@gmail.com

PENDIDIKAN

Program	Bidang	Institusi	Tempat	Tahun Kelulusan
Postdoct	BioEcology	Univ. of Sydney	Sydney, Australia	1997
S3 (PhD)	Marine Biology	Univ. of Sydney	Sydney, Australia	1996
S2 (MSc)	Marine Biology / Akuakultur	Univ. of Wales	Bangor, North Wales, U.K.	1990
S1 (Ir)	Akuakultur	UNDIP	Semarang, Indonesia	1986

PUBLIKASI :

A. Jurnal 3 tahun terakhir:

1. Nanlohy, H., Bambang, A.N., Ambariyanto and Hutabarat, S. 2015. Coastal Communities Knowledge Level on Climate Change As a Consideration in Mangrove Ecosystems Management in the Kotania Bay, West Seram Regency. *Procedia Environmental Sciences* 23:157–163. doi:10.1016/j.proenv.2015.01.024 ISSN: 1878-0296 <http://www.sciencedirect.com/science/article/pii/S1878029615000250>
2. Diah Permata Wijayanti, Elis Indrayanti, Wandu Febrian Asri, **Ambariyanto**. 2015. Growth of *Favia* and *Favites* Coral Transplants Based on Polyps Number. *Ilmu Kelautan*. 20(1):23-32 <http://ejournal.undip.ac.id/index.php/ijms/article/view/8828> DOI: 10.14710/ik.ijms.20.1.23-32
3. Pra Luber Agung Wibowo, Agus Hartoko, **Ambariyanto** Ambariyanto. 2015. Land Subsidence Affects Coastal Zone Vulnerability. *Ilmu Kelautan*. 20(3):127-134. <http://ejournal.undip.ac.id/index.php/ijms/article/view/9705> DOI: 10.14710/ik.ijms.20.3.127-134

4. Haryono, F.E.D., Hutabarat, S., Hutabarat, J. and Ambariyanto, A., 2016. Comparison Of Spiny Lobster (*Panulirus* Sp.) Populations From Bantul And Cilacap, Central Java, Indonesia. *Jurnal Teknologi*, 78(4-2). <http://www.jurnalteknologi.utm.my/index.php/jurnalteknologi/article/view/8152>
5. Murwani, R., Putra, H.S.A., Widiyanto, H., Trianto, A. and Ambariyanto, A., 2016. Shrimp Paste “Terasi” Volatile Compounds From Northern Coast Of Central Java. *Jurnal Teknologi*, 78(4-2). <http://www.jurnalteknologi.utm.my/index.php/jurnalteknologi/article/view/8203>
6. Siwat V., Ambariyanto A., Widowati I., 2016 Biometrics of bigeye scad, *Selar crumenophthalmus* and shrimp scad, *Alepes djedaba* from Semarang waters, Indonesia. *AAAL Bioflux* 9(4):915-922. <http://www.bioflux.com.ro/home/volume-9-4-2016/>
7. Utama, Y.J., Ambariyanto. 2017, February. Achieving Research University: Indonesian Case. In IOP Conference Series: Earth and Environmental Science (Vol. 55, No. 1, p. 012072). IOP Publishing. <http://iopscience.iop.org/article/10.1088/1755-1315/55/1/012072>
8. Pusparini, N., Prasetyo, B., Ambariyanto and Widowati, I., 2017, February. The Thermocline Layer and Chlorophyll-a Concentration Variability during Southeast Monsoon in the Banda Sea. In IOP Conference Series: Earth and Environmental Science (Vol. 55, No. 1, p. 012039). IOP Publishing. <http://iopscience.iop.org/article/10.1088/1755-1315/55/1/012039>
9. Ambariyanto., 2017, Conserving endangered marine organisms: causes, trends and challenges. In IOP Conference Series: Earth and Environmental Science (Vol. 55, No. 1, p. 012002). IOP Publishing. <http://iopscience.iop.org/article/10.1088/1755-1315/55/1/012002>
10. Ulmursida A., Ambariyanto A., Trianto A., 2017 Antibacterial activity o mangrove *Avicennia marina* leaves extract against *Virgibacillus marismortui* and *Micrococcus luteus* bacteria. *AAAL Bioflux* 10(2):372-380. <http://www.bioflux.com.ro/home/volume-10-2-2017/>
11. Prasetya, J.D. Supriharyono, Ambariyanto, and Purwanti, F., 2017. Diversity Based Sustainable Management for Seagrass Ecosystem: Assessing Distribution and Diversity of Seagrass in Marine Protected Area. *Advanced Science Letters*, 23(3), pp.2413-2415. <http://www.ingentaconnect.com/content/asp/asl/2017/00000023/00000003/art00224>
<https://doi.org/10.1166/asl.2017.8665>
12. Utama, Y.J., Purwanto, Ambariyanto. 2017. Developing Environmentally Friendly Campus at Diponegoro University. *Advanced Science Letters*, 23(3), pp.2584-2585. <http://www.ingentaconnect.com/content/asp/asl/2017/00000023/00000003/art00277>
<https://doi.org/10.1166/asl.2017.8712>
13. Johan Danu Prasetya, Ambariyanto, Supriharyono, and Frida Purwanti. 2017. Mangrove Health Index as Part of Sustainable Management in Mangrove Ecosystem at Karimunjawa National Marine Park Indonesia. *Adv. Sci. Lett.* 23, 3277–3282 (2017)
14. Hartati, R., Widianingsih, Trianto, A., Zainuri, M. & Ambariyanto. 2017. The abundance of prospective natural food for sea cucumber *Holothuria atra* at Karimunjawa Island waters, Jepara, Indonesia. *Biodiversitas*. 18(3): 947-953. doi: 10.13057/biodiv/d180311
15. Haryono, F.E., **Ambariyanto**. 2017. Genetic Diversity Approach to Fishery Management Spiny Lobster Southern Waters of Java Based on SWOT Analysis and AHP. *Omni-Akuatika*, 13(1): 26-33.
16. Handhani A. R., Ambariyanto A., Supriyantini E., 2017 Reduction of Pb concentration in seawater by seaweed *Gracilaria verrucosa*. *AAAL Bioflux* 10(4):703-709.
17. Pertiwi, N.P.D., Nugraha, B., Sulistyansih, R.K., Jatmiko, I., Sembiring, A., Mahardini, A., Cahyani, N.K.D., Anggoro, A.W., Madduppa, H.H., Ambariyanto, A. and Barber, P.H. 2017. Lack of differentiation within the bigeye tuna population of Indonesia. *Biodiversitas*, 18(4): 1406-1413. DOI: 10.13057/biodiv/d180416 <http://biodiversitas.mipa.uns.ac.id/D/D1804.htm>

B. Buku (3 tahun terakhir):

1. Agus Dermawan, Ngurah Wiadnyana, Syafrudin Yusuf, Ambariyanto. 2015. Pedoman Pengkayaan Populasi Kima. Direktorat Konervasi dan Keanekaragaman Hasil Laut. Kementerian Kelautan dan Perikanan. 72 hal.
2. Winarno, F.G, dan Hariyadi, P (Eds). 2017. The Indonesian Sago Palm. Unraveling its Potential for National development. Team of Writers: Ambariyanto, B.P. Widyobrooto, B. Arifin, E. Handayanto, F.M. Dwivany, P. Haryadi, W. Lukito, and W.T. Koesoemo. PT. Gramedia Pustaka Utama. 92 pp

3. Winarno, F.G., Handayanto, E., dan B. Arifin (Eds). 2017. Cabai. Potensi Pengembangan Agrobisnis dan Agroindustri. Tim Penulis: B. Arifin, W.T. Koesoemo, Ambariyanto, E. Handayanto, dan F.M. Dwivany. PT. Gramedia Pustaka Utama. 199 pp.

Semua data yang saya isikan dan tercantum dalam biodata ini adalah benar dan dapat dipertanggungjawabkan secara hukum. Apabila di kemudian hari ternyata dijumpai ketidaksesuaian dengan kenyataan, saya sanggup menerima sanksi

Semarang, Agustus 2018



Prof.Dr.Ir. Ambariyanto, MSc.

Curriculum vitae Anggota peneliti 3

1. Identitas Peneliti

- a. Nama : Ir. Widianingsih, MSc.
 b. Tempat dan Tanggal Lahir : Jakarta, 25 Juni 1967
 c. Kedudukan/ Jabatan : Lektor Kepala
 d. Alamat Kantor : Kampus Ilmu Kelautan FPIK Undip
 Jl. Prof. Sudarto, Tembalang Semarang 50239
 Telp/Fax Kantor : 024 7474698
 e. Alamat Rumah : Perum Bulusan XVI/342 Tembalang Semarang
 No Tlp/Fax : 024 76480155/-
 Email : widia2506@yahoo.com
 Hp : 02470120415

2. Pendidikan

UNIVERSITAS/ INSTITUT DAN LOKASI	GELAR	TAHUN SELESAI	BIDANG STUDI
Institut Pertanian Bogor	SARJANA/Ir	1991	Marine Science
Aarhus University -Denmark	Master of Science	2001	Marine Science

3. Pengalaman kerja dalam penelitian dan pengalaman profesional serta kedudukan saat ini

INSTITUSI	JABATAN	PERIODE KERJA
LIPI	Researcher Staf Pengajar	1991 – 1993 1994 – sekarang
FPIK- Undip	Sekretaris Lab. Pengelolaan Lingkungan Pantai dan Laut	2001 – 2008

4. Pengalaman penelitian yang Dilakukan yang berhubungan dengan proposal :

Judul Penelitian	Sumber Pendanaan	Tahun
Kajian Fenotip dan genotip Teripang Famili Stychopodidae dan Famili Holothuroidea dari Kepulauan Karimunjawa	Kemenristekdikti (Ketua Anggota)	2015
Teknologi Produksi benih Teripang Tril <i>Stichopus hermannii</i> Melalui Reproduksi Aseksual	Kemenristekdikti (Peneliti Anggota)	2015- 2016
Mapping keanekaragaman Hayati Pesisir dan Laut di Area PLTU Tanjung Jati B, Jepara.	PLTU TJ B	2013.
Pengkajian Ekosistem Sumberdaya Ikan di Kawasan Konservasi Perairan Kepulauan Karimunjawa, Jawa Tengah	BPKSI	2012- 2013
Eksplorasi mikroalga laut yang berpotensi sebagai biofuel sebagai upaya pencaharian energi yang terbarukan	Program Hibah Kompetensi (Peneliti Ketua)	2009- 2011
Diversifikasi Usaha Budidaya Laut Melalui pembesaran Teripang Dengan teknologi Cage Culture Untuk Meningkatkan Pendapatan kelompok Nelayan	Program VUCER (Pelaksana Ketua)	2009
Ultrastruktur Alimentary canal dan absorpsi pakan teripang (Echinodermata : Holothuroidea) Pada Berbagai	Penelitian Fundamental (Peneliti Anggota)	2009
Teripang (Holothuroidea : Echinodermata) di Indonesia : Biologi, Budidaya dan Konservasinya	Program beasiswa Unggulan Diknas (Penulis Pertama)	2009
Fission Reproduction Sebagai Teknik Perbanyakkan individu Dalam Konservasi Teripang Holothuria : Echinodermata).	Program Hibah Penelitian Strategis Batch II (Peneliti Anggota)	2009

D. Pengalaman Pengabdian Kepada Masyarakat dalam 5 Tahun Terakhir

No.	Tahun	Judul Pengabdian Kepada Masyarakat	Pendanaan	
			Sumber*	Jumlah (juta Rp.)
1	2009	Diversifikasi Usaha Budidaya laut melalui Pembesaran teripang dengan teknologi Cage culture untuk meningkatkan pendapatan keompok nelayan,	DP4M (Dikti)	10
2	2010	Coastal clean-up Karimunjawa 2010 sebagai upaya konservasi lingkungan laut di Kepulauan Karimunjawa	FPIK Undip	10
3	2010	I _b M Petani Pembudidaya Artemia di Tambak Garam Kec. Trangkil-Kab. Pati,	DP4M (Dikti).	10
4	2010	I _b M Kelompok Usaha Kerupuk Ikan dan Udang di kelurahan Mangunharjo, Kecamatan Tugu, Semarang.	DP4M (Dikti).	10
5	2012	Optimasi Pemanfaatan Tambak Tidak Produktif dan Diseminasi Konservasi Mangrove	MFF	225
6	2013.	I _b M Kelompok Nelayan Pembudidaya Teripang di Kepulauan Karimunjawa Jepara..	DP2M-DIKTI-	50

* Tuliskan sumber pendanaan baik dari skema pengabdian kepada masyarakat DIKTI maupun dari sumber lainnya.

E. Publikasi Artikel Ilmiah Dalam Jurnal alam 5 Tahun Terakhir

No.	Judul Artikel Ilmiah	Nama jurnal	Volume/Nomer/ Tahun
1	Fission Reproduction of Four Stichopudidae Species (Holothuria:Echinodermata).	Ilmu Kelautan	18/2/2013
2	Fatty acid composition of marine microalgae in Indonesia	Journal of tropical Biology and Conservation	-/10/2013
3	Stimulasi Reproduksi Aseksual Pada <i>Stichopus horrens</i> dan <i>Stichopus vastus</i> di Perairan Pulau Karimunjawa, Kabupaten Jepara	Journal Of Marine Research	1/2/2012
4	Kajian kadar total lipid dan kepadatan <i>Nitzschia</i> sp. yang dikultur dengan salinitas yang berbeda	Metana	7/1/2012
5	Pengaruh Pengurangan Konsentrasi Nutrien Fosfat dan Nitrat Terhadap Kandungan Lipid Total <i>Nannochloropsis oculata</i> .	Ilmu Kelautan	16/1/2011
6	Komposisi Jenis dan Kelimpahan Diatom Bentik di Muara Sungai Comal Baru Pematang.	Ilmu Kelautan	16/1/2011

F. Pemakalah Seminar Ilmiah (Oral presentation) dalam 5 Tahun terakhir

No.	Nama pertemuan Ilmiah/Seminar	Judul Artikel Ilmiah	Waktu dan Tempat
1	Seminar Nasional Moluska 2	Identifikasi dan kelimpahan gastropoda di kawasan Sungai Ijo Bodo-Kebumen dan Sungai Adiraja-Cilacap.	11-12 Feb. 2009; IPB-Bogor
2	Seminar Nasional Moluska 2	Kajian morfologi dan indeks kondisi kerang coklat (<i>Perna perna</i> Linnaeus,	11-12 Feb. 2009 IPB, Bogor

		1758) di Pantai Teleng Ria, Kab. Pacitan	
3	Seminar Nasional bidang Biologi	Sea cucumbers of Karimunjawa Island-Jepara.	12-12-2009, UnSoed, Purwokerto
4	International Convergence on Management Innovation and Technology In cooperation with ASEAN Uninet.	Fission Reproduction of Four Stichopudidae Species As Prospective Methods of Seed Production For Seacucumber Culture and Conservation (Holothuria : Echinodermata).	27-10-2010, Gumaya Tower Hotel Semarang
5	Third International Conference and Workshop on Basic and Applied Science	Community structure of phytoplankton in Plawangan, Klaces, and Donan Segara Anakan Lagoon between February-June 2005	21-23 Sept.2011 Unair & UTM Malaysia, Surabaya
6	Seminar Nasional Tahunan IX Hasil penelitian Perikanan dan Kelautan	<i>Fission Reproduction</i> Dua Spesies Teripang Ekonomis Penting Famili Stichopudidae (Holothuria : Echinodermata).	14 Juli 2012 Jur. Perikanan, Faperta, UGM,
7	Seminar Nasional Tahunan IX Hasil penelitian Perikanan dan Kelautan	Kajian Kadar Total Lipid dan Kepadatan <i>Nitzschia</i> sp. Yang Dikultur Dengan Salinitas Yang Berbeda.	14 Juli 2012 Jur. Perikanan, Faperta UGM,
8	Seminar Nasional Tahunan IX Hasil penelitian Perikanan dan Kelautan	Komposisi Makrozoobentos Di Perairan Morosari dan Pandansari, Desa Bedono, Kecamatan Sayung, Kabupaten Demak.	14 Juli 2012 Jur. Perikanan, Faperta UGM,
9	Seminar Nasional Kimia dan Pendidikan Kimia IV (SN-KPK IV),	Karakteristik Spesifikasi Biodiesel Berbahan Baku Mikroalga Laut <i>Nitzschia</i> sp	31-3-2012. FKIP UNS, Surakarta,
10	Seminar Nasional Ke II Hasil-hasil penelitian Perikanan & Ilmu Kelautan Undip	Kajian Kadar Total Lipid Dan Kepadatan <i>Nitzschia</i> Sp Yang Dikultur Dengan Salinitas Yang Berbeda.	4 Oktober 2012, Undip, Semarang
11	Seminar Nasional Ke II Hasil-hasil penelitian Perikanan & Ilmu Kelautan Undip	Pemanfaatan Air Limbah Hatchery Sebagai Media Kultur Mikroalga <i>Chaetoceros calcitrans</i> .	4 Oktober 2012, Undip, Semarang
12	Indian Ocean and Pacific Conference (IOPAC) 2013	Intergrated Conservation for Food Security and Environment Resilience : Case study of two coastal village of Semarang	June 18 th – 20 th , 2013; Nusa Dua Bali,
13	Seminar Nasional Tahunan X Hasil Penelitian Perikanan dan Kelautan	Optimalisasi Total Lipid Mikroalga <i>Nannochloropsis oculata</i> Melalui Media Kultur dengan Intensitas Cahaya Yang Berbeda.	23-8-2013, Jur. Perikanan, Faperta, UGM

G. Karya Buku dalam 5 Tahun terakhir

No.	Judul Buku	Tahun	Jumlah Halaman	Penerbit
1	Abalon & Rumput Laut.	2008	94	Navila Idea. Yogyakarta.
2	Pembenihan dan pembesaran Teripang Pasir (Echinodermata: Holothuroidea).	2009	128	Badan penerbit Universitas Diponegoro. Semarang
3	Teripang (Holothuroidea : Echinodermata) di Indonesia : Biologi, Budidaya dan Konservasinya.	2009	72	Navila Idea Yogyakarta.
4	Mikroalga Laut	2009	141	Badan penerbit Universitas Diponegoro Press.

Semua data yang saya isikan dan tercantum dalam biodata ini adalah benar dan dapat dipertanggungjawabkan secara hukum. Apabila di kemudian hari ternyata dijumpai ketidaksesuaian dengan kenyataan, saya sanggup menerima sanksi.

Semarang, Desember 2018
Anggota Peneliti



Ir. Widianingsih, MSc.

NIP. 19670625 199403 2 002